

PRACTICAL ACTION
Technology challenging poverty

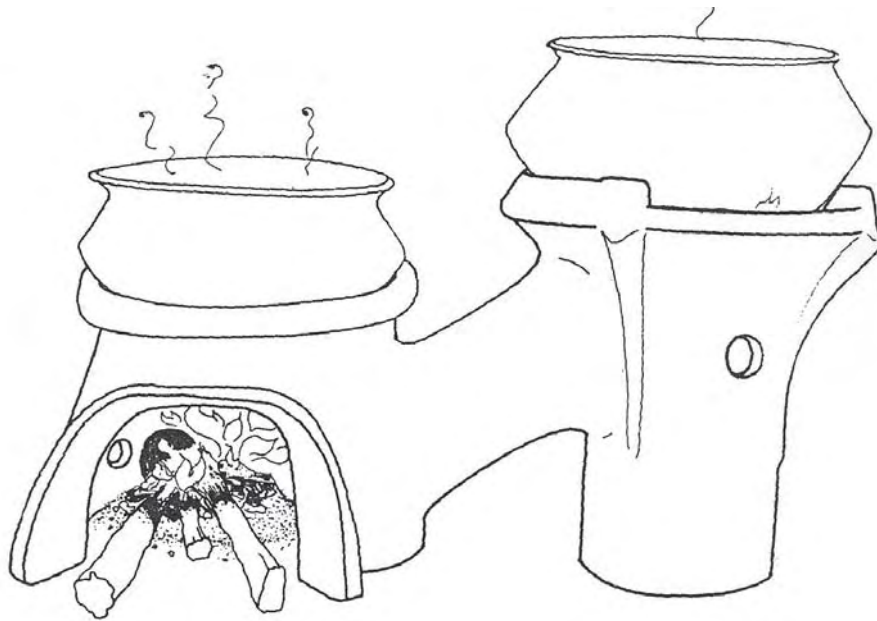

HOW TO MAKE SRI LANKA'S ANAGI II STOVE



technical guide

Table of Contents

Introduction to the Anagi II stove	3
Hot it saves fuel and time	3
Overview of construction procedure	3
The Design	3
Tools, Templates, and Moulds	5
Throwing tools and templates	5
Assembly tools, templates and moulds	6
Finishing tools	6
Throwing the Three Main Pieces	8
General notes	8
Description of the Thrown Pieces	9
Affixing the throwing pallet	10
Throwing the firebox	11
Throwing the tunnel	13
Throwing the second pothole	15
Assembly Procedure	17
General notes	17
Joining the main pieces	18
Adding the baffle	20
Adding the second-pot potrests	21
Adding the buttresses	22
Adding the flame shield	23
Adding the door	23
Adding the firebox potrests	25
Cutting the holes	26
Final checking	26
Smoothing and marking the stove	26
Finishing Procedure	27
Drying and Firing	28
Quality Control after Firing	29
Acknowledgements	30
Appendices	
Appendix 1: Pallet dimensions and plan	
Appendix 2: Full-size patterns for templates	
Appendix 3: Making the moulds, with full-size mould plans	

technical guide

Introduction to the Anagi II Stove

How it Saves Fuel and Time and Reduces Smoke

The Anagi II stove encloses the cooking fire with insulating ceramic, protecting it from cooling draughts. What would be smoke in a traditional stove is burned as flame, raising the temperature of the hot gases. The stove then guides the hot gases across the bottom of 2 pots.

Field tests show that by cooking two pots at once, one and one-half hours may be saved each day in cooking time in the Sri Lankan kitchen.

Properly constructed and operated, the Anagi II will use up to 30% less wood than traditional open hearths. It will also greatly reduce the smoke women are exposed to while cooking: smoke which causes eye and lung disease. If the stove is smoky, there is too much fuel in it. Remove a few sticks of wood for a hotter, faster, more fuel-efficient fire.

The firebox is designed to accommodate coconut shells and palm fronds as well as wood.

Overview of the Construction Procedure

The Anagi II stove can be made profitably by teams of 1 potter and 4 assemblers/finishers. Each team can make 25-30 stoves per day. The potter throws the 3 main pieces. The next day an assembler joins the main pieces and adds the smaller pieces all of which are formed using plaster press moulds. Air holes are cut, the stove is checked for quality control, and the surface is smoothed. The factory logo and "Anagi II" are stamped, and the full date and assembler's initials inscribed. The assembly procedure takes about 50 minutes.

After 3 days of stiffening, the stove is removed from its special pallet, and any sharp edges are carved away. The surface is rubbed smooth, and when "finished," the stove is set on racks to dry thoroughly. It is then fired to a hard, porous state: 850 to 900°C.

The clay used in making the stove at tile factories consists of 8 parts tile clay: 1 part sand: 1 part grog (crushed fired clay), by Volume. This mixture enables the stove to be fired on top of the stack of tiles in the kilns, space which is often not utilised. The addition of sand and grog to the clay prevents damage which would otherwise occur due to higher temperatures in the top of the kiln.

This manual provides illustrations for all steps in construction, and plans for all tools, moulds, and templates. Included is a discussion of drying and firing, and quality control checking procedures throughout.

Throwing the main pieces should only be done by a previously skilled potter. Likewise, the plaster mould should be made by a person who has already been trained in mouldmaking, as there are subtleties to the skills which are beyond the scope of this manual.

The Design

The parts of the Anagi II stove are labelled in the following diagrams. Wet clay dimensions are given, with fired clay dimensions in parentheses following. (The fired dimensions are 10% less due to shrinkage.) Correct dimensions are essential to assure that the stove can be used to cook quickly, using a minimum of woodfuel. The combination of the baffle and the flame shield assure even heating on the second pot, and the shield provides a safety feature of keeping flames away from the first pot.

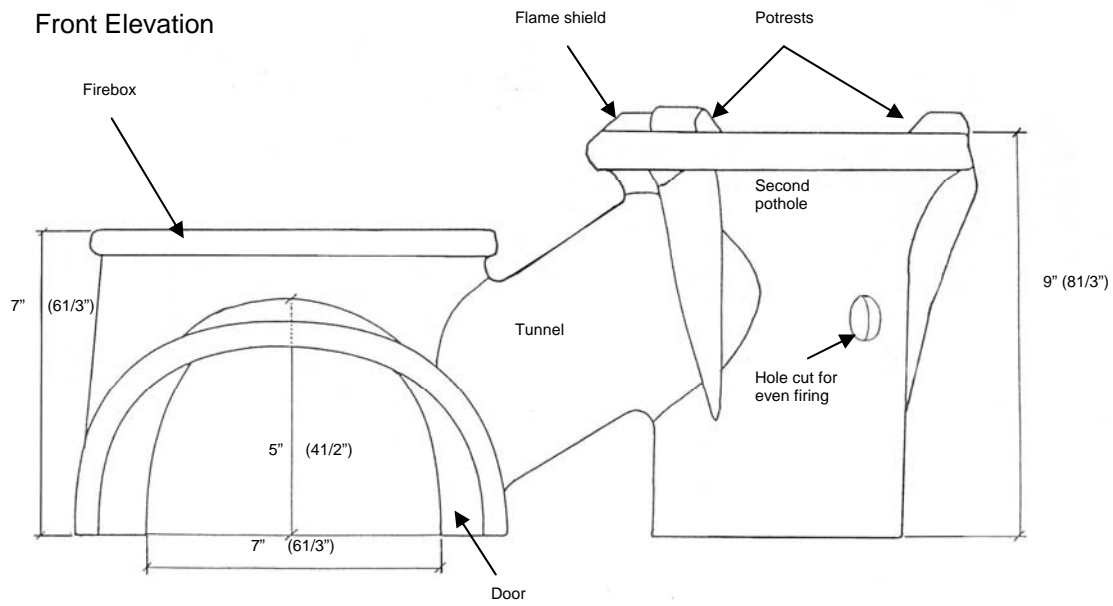

Cross-section

Dimensions in inches: wet (fired)
Not to scale

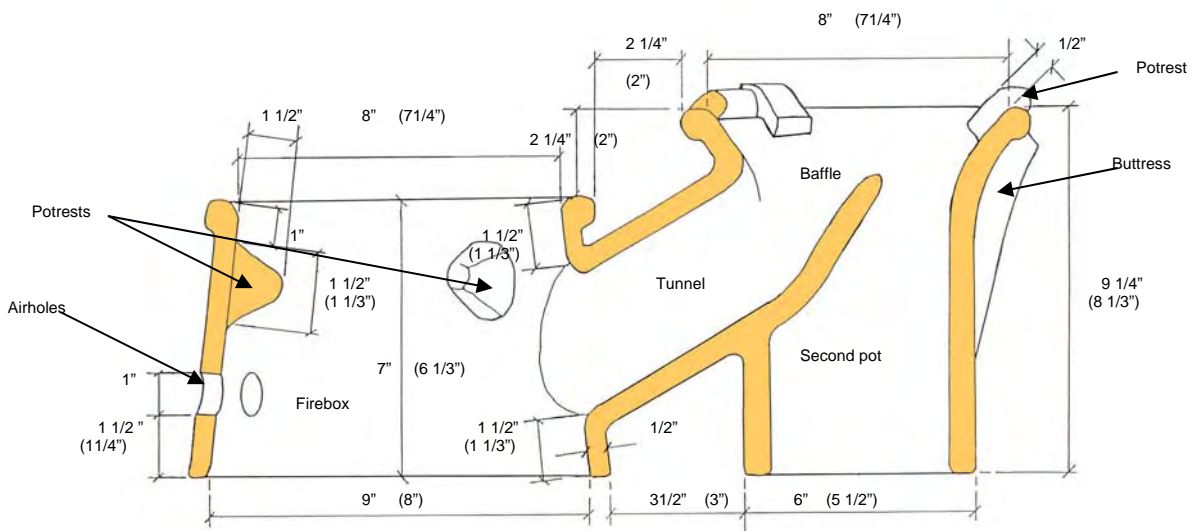

technical guide

Top view

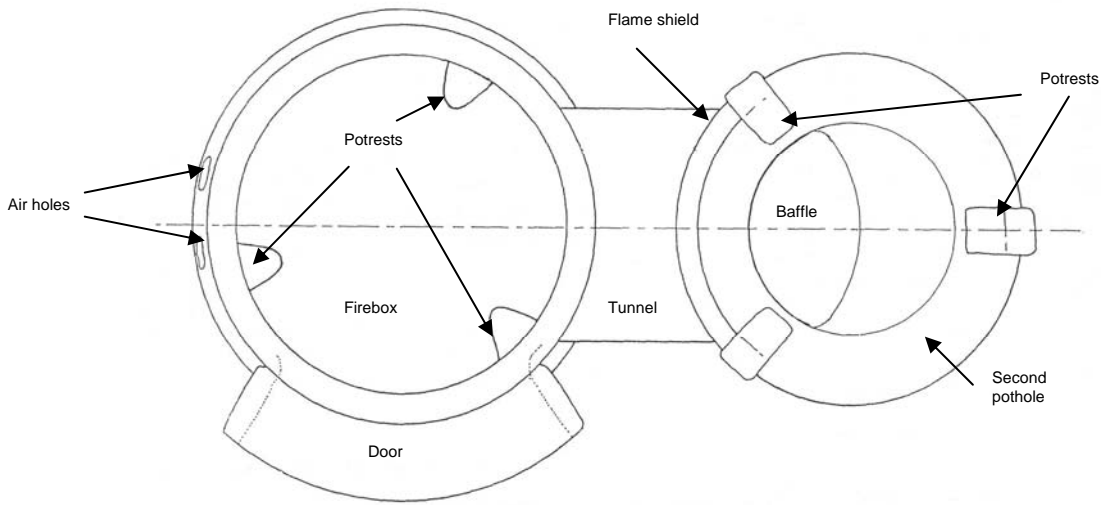

Tools, Templates and Moulds

Throwing Tools

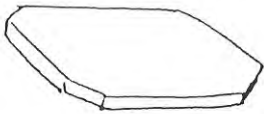

Throwing pallet (plans in appendix 1)

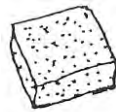

Sponge



String or wire for cutting



Folded strip of folded cloth



Bucket of water



Hard wood or bamboo "rib"

technical guide

Throwing Templates

Firebox

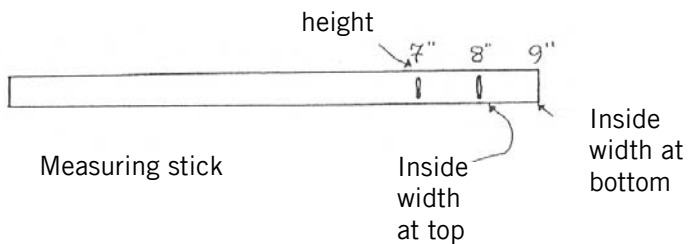

Tunnel

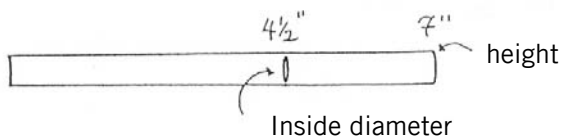

String or wire for cutting

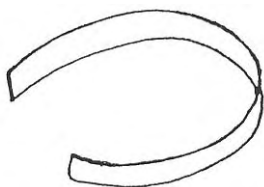

17" long strip of vinyl gives circumference

Second Pothole

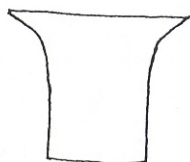
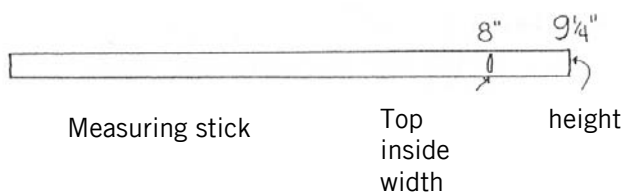

Inside shape template (wood)

Assembly Tools

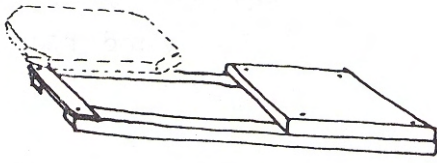

Support pallet (plans given in Appendix 1)



Knife (hacksaw blade)

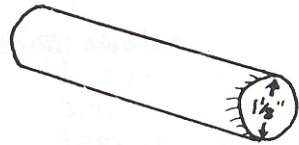

Sharpened PVC or metal pipe



Coconut oil



Slip (clay & water)



Brush



Comb

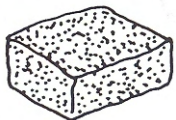

sponge

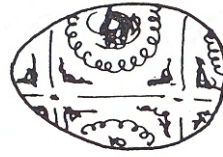

Baffle (vinyl)



Tunnel support (wood)

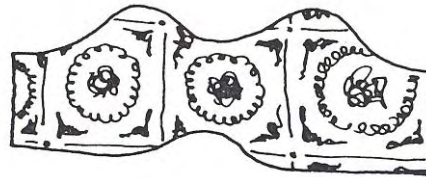

Tunnel (vinyl)

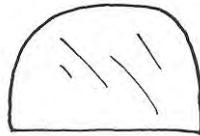

Door (sheet metal)

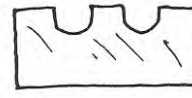

air holes (sheet metal)

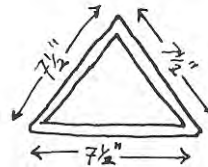

Potrest maker (wood)



Pot (aluminium) with hole in bottom

technical guide

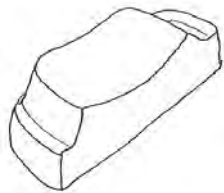

Door

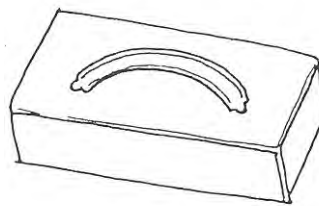

Flame shield

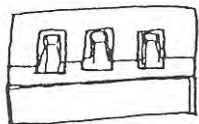

Second pot prorests



Carving tool (steel blade, wood handle)

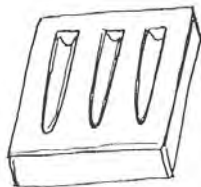

Buttresses

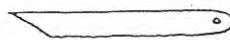

Knife (hacksaw blade)

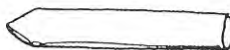

Hard wood or bamboo stick



Baffle

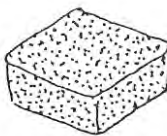

Sponge



Firebox potrest



Bucket of water

Throwing the three main pieces

The three main pieces: the firebox, the tunnel, and the second pothole, are thrown on a pottery wheel by a skilled potter. The traditional hand-turned Sri Lankan wheel can be used with or without an assistant to turn the wheel, depending on the strength of the potter. Treadle wheels, such as those introduced by the Department of Small Industries, have also been used with success.

With either wheel, a wooden throwing pallet must be attached to the wheel and the pieces thrown on the pallet. The exception is the tunnel piece, which is cut and lifted from the wheel (or pallet), pressed into an oval and set to stiffen on a shelf. The larger pieces must only be moved on the pallet to prevent distortion.

It is recommended that the potter throws the fireboxes in the morning and the tunnels and the second potholes in the afternoon. The smaller pieces will stiffen more quickly than the

heavier firebox. If thrown in the morning, some of the smaller pieces may be too dry for assembly the following day.



Description of the Thrown Pieces

None of the thrown pieces has a bottom.

It is important to have an even wall thickness on the pieces, between 1/2" and 3/4" for the tunnel and second pothole, and up to 1" for the firebox. Skill and practice is necessary to be able to throw the pieces so that the bottoms are not thicker than the tops. During the training period cut the thrown pieces in half vertically, using a string to inspect the wall thickness.

Note the thick, sturdy folded rim on the firebox. There is a smaller, but still significant rim on the second pothole. Thick rims are necessary to prevent warpage and give strength to the stove.

While the potter is learning to throw the pieces it is useful to weigh the clay so that there is sufficient clay on the wheel to make the pieces. Once the potter has a sense for the necessary amount, weighing the clay is not helpful.

Start with 4 kg clay for the firebox, 1.5 kg clay for the tunnel, and 3 kg clay for the second pothole. Three tunnels can be thrown in succession from one lump of clay once the technique is mastered.

Perspective

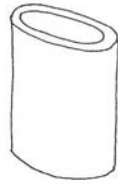
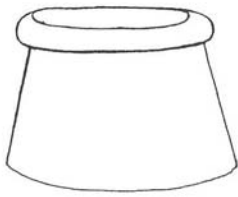

Top view

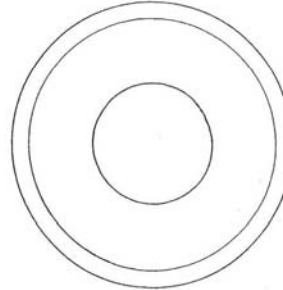
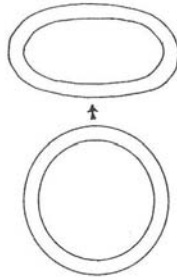
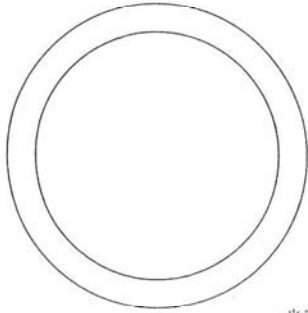

Cross Section

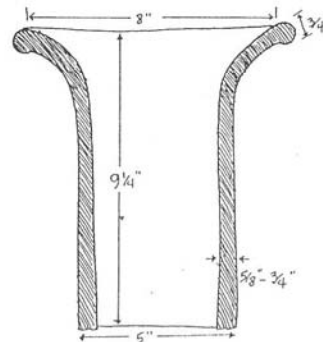
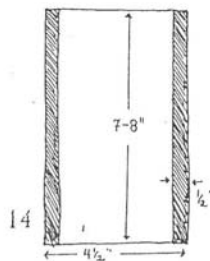
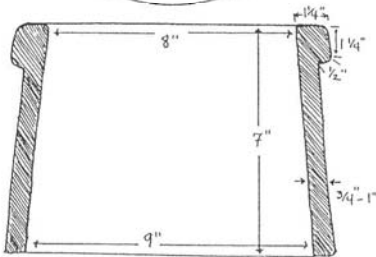

Firebox

Tunnel

Second Pothole

Affixing the Throwing Pallet



1. Flatten two lumps of clay onto the wheel. These will grab onto the pieces of wood on the bottom of the throwing pallet.

2. Centre the throwing pallet on the wheel.

3. Press the pallet into the clay to hold it in place.

technical guide

Throwing the Firebox



4. Slap clay onto the pallet while turning the wheel.



5. Scrape clay off the sides and slap it on top.

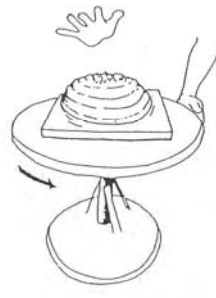

6. Add more clay and repeat the motions.



7. Wet the clay and hand, and centre the clay.



8. Pulling inwards and upwards, raise the outer part of the clay.

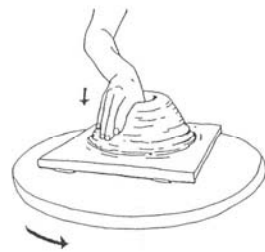

9. Push downwards with the thumb in the centre.



10. Use the palm, pulling towards yourself to open the clay wider.

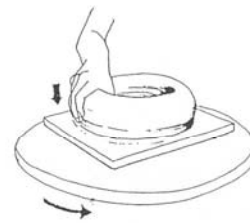

11. Again with thumb in the centre, compress downwards.



12. Raise wall with thumb inside.

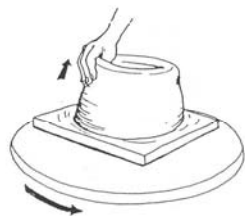

13. Raise wall again.



14. Raise wall a third time. End the motion by flaring the lip.

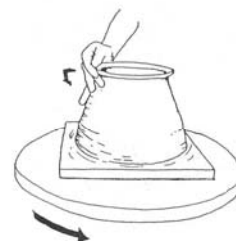

15. Fold down the lip.

technical guide

technical guide



16. Remove excess clay from the inside bottom

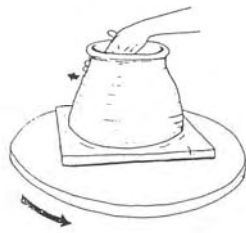

17. Using one hand inside and one outside, raise and compress the wall.



18. Remove excess clay from the inside bottom again.



19. Using a wooden "rib", straighten the wall and remove excess clay.



20. Use a sturdy wet cloth to flare the lip.



21. Fold the lip down more than 1".

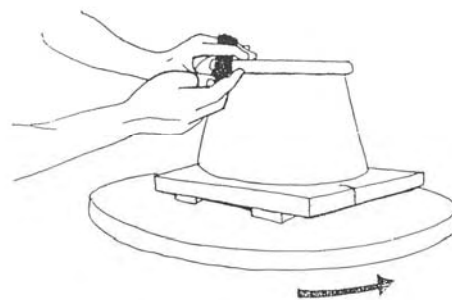

22. Compress the rim with the wet cloth.



23. Use a wooden rib to make the joint strong.



24. Make the rim absolutely level.

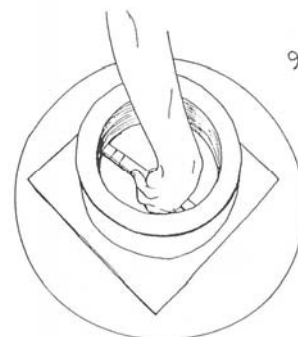

25. Check the inside width at the bottom by placing the measuring stick inside. The inside bottom should be 9" wide.

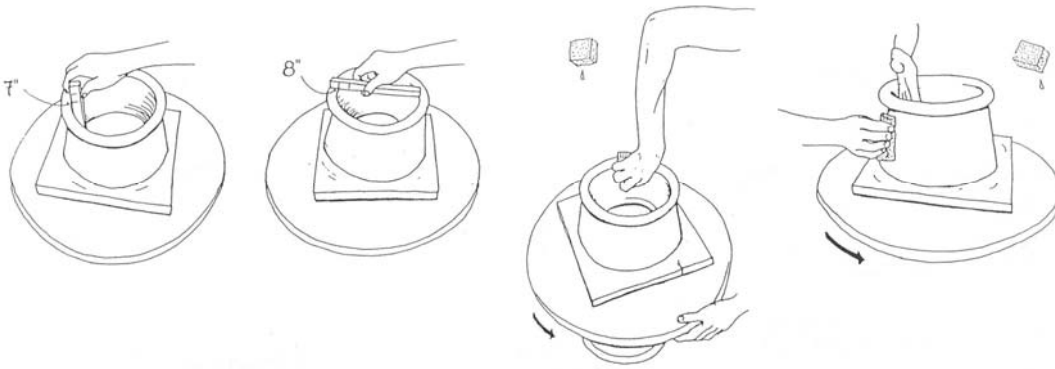

26. Check the height with the measuring stick – it should be 7”.

27. Check the inside width at the top – it should be 8”.

28. Rub a damp sponge over the inside and the rim.

29. Rub a damp sponge over the outside.



30. Use a piece of string to cur the firebox from the pallet.

31. Leaving the firebox in place, lift the pallet from the wheel.

32. Place the pallet and the firebox on a shelf for overnight stiffening.

Throwing the tunnel

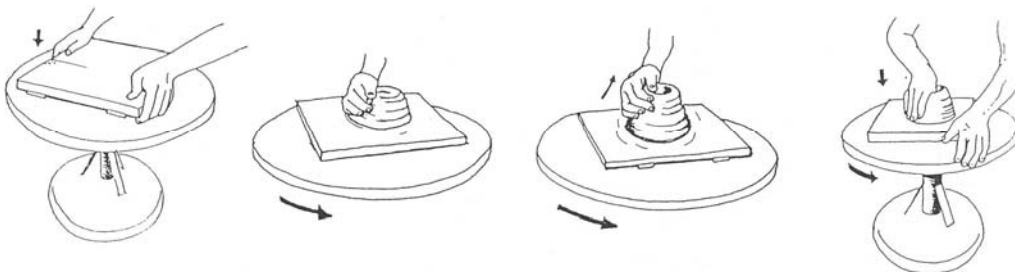

33. Centre and attach a throwing pallet to the wheel.

34. Add and centre clay.

35. Raise the outside of the clay.

36. Compress down with thumb in centre.

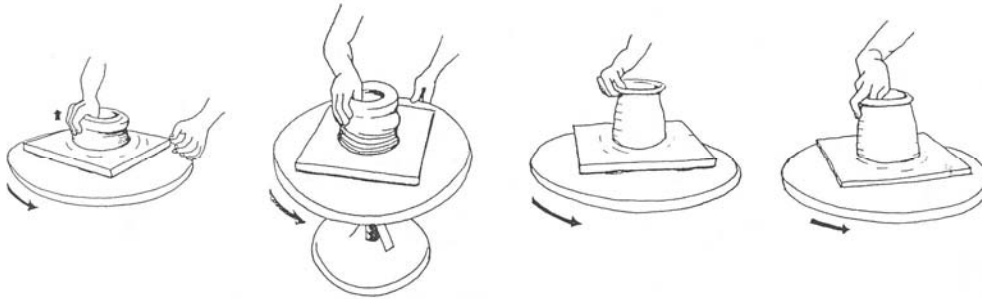

37. Still with thumb in the centre, raise the wall.

38. Raise the wall a second time.

39. Flare the lip.

40. Fold the lip downwards.

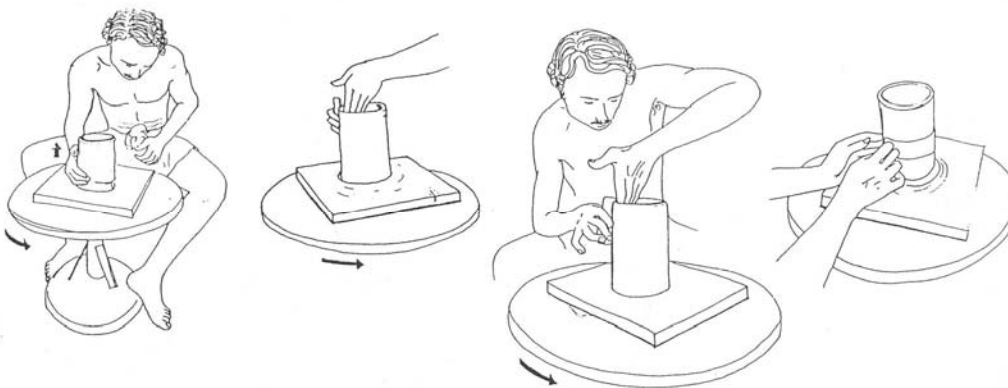

41. With the hand on the outside, raise the wall.

42. Use two hands to further raise and straighten the wall.

43. With one hand inside, and the outside hand holding a wooden rib, further straighten the wall.

44. Check, the diameter by wrapping the vinyl template around the pot. The edges should meet but not overlap.

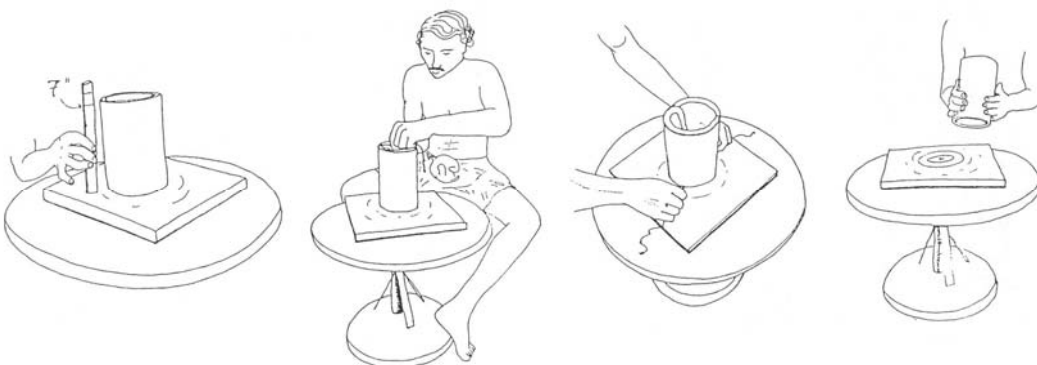

45. Check that the height is at least 7" with the measuring stick.

46. Cut off the very top of the piece using the string.

47. Cut the piece off the pallet using the string.

48. Remove the piece from the bat.

technical guide

Throwing the second pothole



49. Press the sides of the tunnel to make it an oval shape. Leave it on a shelf overnight to stiffen.



50. Attach a pallet to the wheel (or use the one left from throwing tunnels).



51. Add clay and centre it.



52. Raise the outside of the clay.

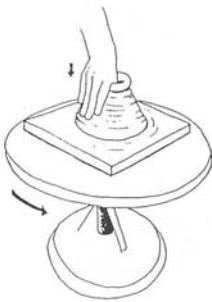

53. Compress downwards with the thumb in the centre.



54. With the hand in the same position, raise the wall.

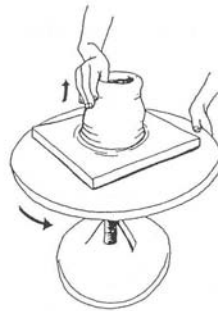

55. Raise the wall a second time. Raise it again if needed.



56. Finish the motion by flaring the lip.



57. Fold the lip down.



58. Remove excess clay from the inside bottom.

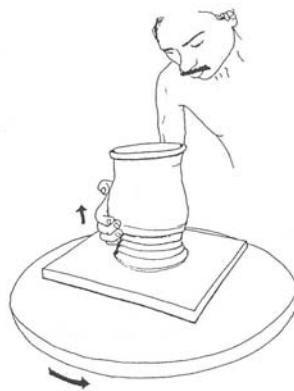

59. Raise the wall with the hand outside.

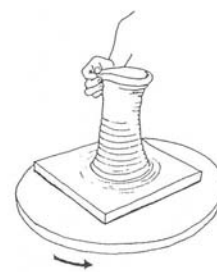

60. Continue raising the wall.

technical guide



61. Open the lip wider



62. Use a wooden rib to remove excess clay from the outside bottom



63. Continue up the wall, removing excess clay and shaping the wall. Clean the rib as needed.



64. Use a wooden rib to remove excess clay from the inside bottom.



65. Using a wet, sturdy cloth, flare the lip.



66. Fold down the lip and compress into a smooth strong joint.



67. Check the height with the measuring stick, it should be 9".



68. Measure the inside width at the top – it should be 8".



69. Sponge the rim, widening or narrowing the width as needed.

technical guide



70. Cut the piece off the pallet with a string.



71. Place the pallet and piece on a shelf. Allow to stiffen overnight.

Assembly Procedure

The assembly procedure takes about 50 minutes to complete. Most unskilled labour can be trained to do it. The use of templates and moulds provides correct dimensions. The assemblers can complete 6 to 8 stoves in one day, and are paid piece rate as are the potters.

If a trainee assembler has trouble learning how to make the stove correctly after one week of training, then she or he is probably not well suited to the job. The main skills to learn are how to use the templates for correct placement, and how to make good joints.

To make a good joint, the clay pieces being joined should have equal or near-equal moisture content. If one is too dry, cracking is likely. With every joint, the following procedure should be applied. Score (scratch the surface) on both sides to be joined, and then apply a thin layer of slip (liquid clay). Press pieces 'together firmly, 'with hands on both' sides. Only then should the joint be smoothed with the fingertips.

A common problem that beginners have is leaving the joints at either end of the tunnel too thick. This constricts the tunnel. The exit and entrance to the tunnel should be as wide of an oval as the centre of the tunnel is.

The plaster moulds should be replaced every 6 months, as they wear down in use and will no longer provide the correct dimensions.

Joining the main pieces



1. Place the firebox pallet onto the support pallet.

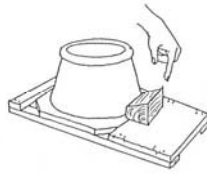

2. Place the wooden tunnel support next to the firebox.



3. Wrap the tunnel template around the tunnel. Cut along the edges.



4. Remove excess clay.



5. Mark the bottom of the tunnel. Remove template.



6. Flare the edges of the tunnel.



7. Score with a comb the opening with the small bumps (the side which was the bottom of the thrown piece).



8. Apply slip to the score marks using a brush or a sponge.

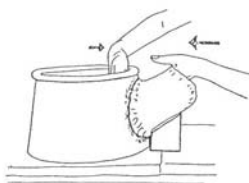

9. With one hand inside the firebox, and the other hand in the tunnel, push the tunnel into place.



10. With fingertips press the joint of the tunnel and the firebox together.

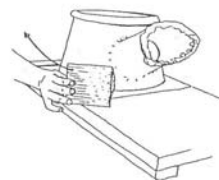

11. When strong and smooth, remove the wooden block.



12. Score and slip the upper end of the tunnel.

technical guide

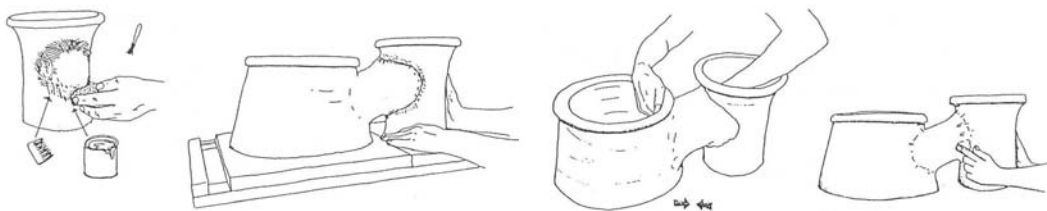

13. Score and slip the second pothole where it will join.

14. Place the tunnel and the second pothole next to each other.

15. With one hand inside the firebox, and one hand inside the second pothole, push the two pieces together.

16. Using fingertips, press the tunnel end onto the second pothole piece to make a good joint.

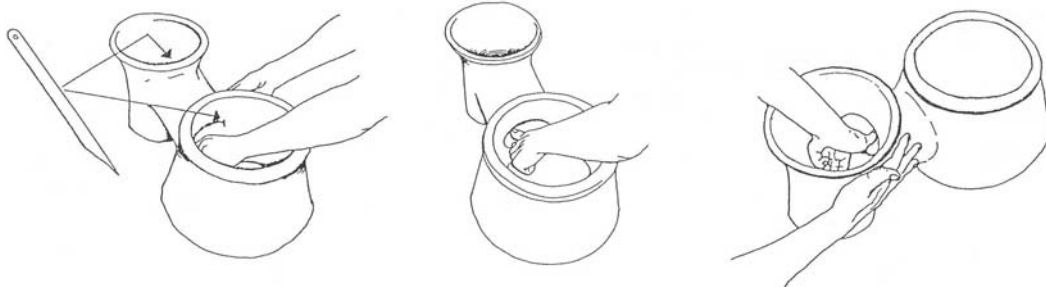

17. Cut open both ends of the tunnel.

18. From inside the firebox, press the tunnel joint to make it strong. Make the opening into the tunnel as wide as the tunnel itself.

19. Do the same thing from inside the second pothole.

technical guide

Adding the baffle



20. Score and slip a line from the bottom of the tunnel up to the sides to a height of 2 inches from the top. The line should extend horizontally across the back half at the same height.

21. Roll out a coil of clay 12" long and 1/2" thick.

22. Press the coil into place.

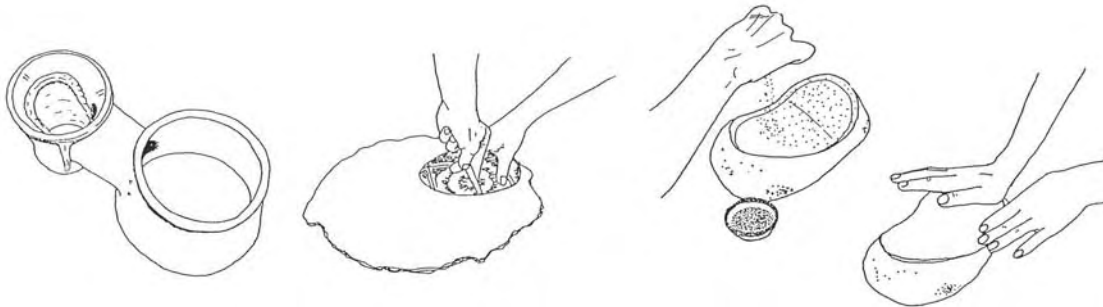

23. The completed coil baffle support.

24. Cut a slab using the baffle template

25. If the mould is new or is there are problems with clay sticking, sprinkle the baffle mould with clay powder.

26. Press the clay slab onto the mould.



27. Lift the baffle from the mould using a small ball of clay.

28. The completed baffle piece.

29. Score and slip the underside edges of the baffle, as well as the coil and stove walls it will join with.

30. Folding slightly the tip of the baffle, place it on the coil and into the edge of the tunnel.

technical guide

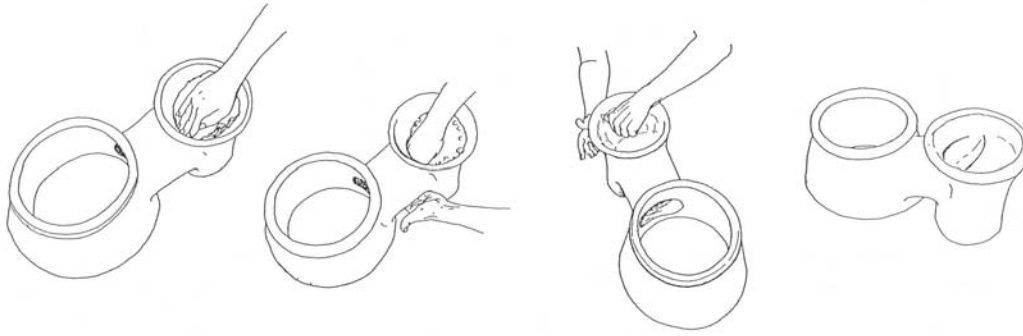

31. Press the baffle into the correct place, forming an extension of the tunnel.

32. Press the edges of the baffle into the adjoining clay.

33. Smooth the edges.

34. The finished baffle.

Adding the second-pot potrest

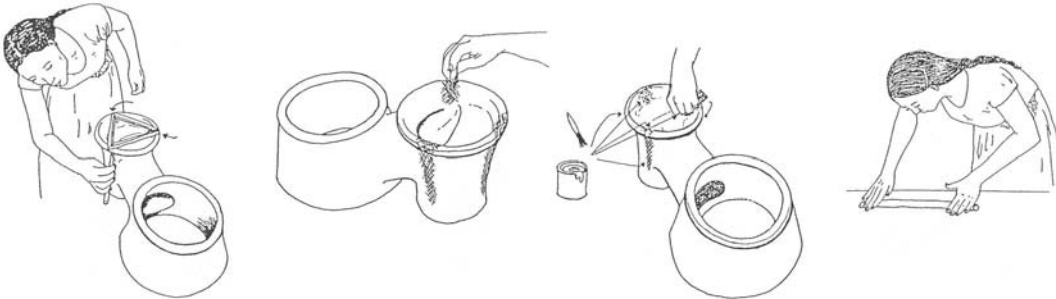

35. Using the triangle template to mark the position of the second pot potrests and buttresses.

36. Score where the potrests and the buttresses will be placed.

37. Apply slip to these same areas using a sponge or a brush

38. Roll out a coil less than one inch thick.

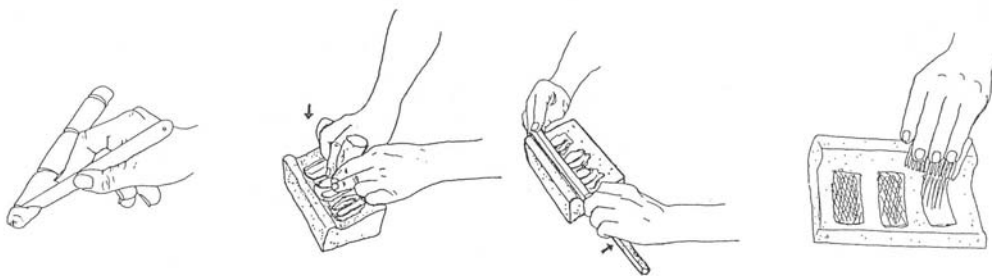

39. Cut off the ends and cut the coil into three pieces about 2" long.

40. Press each piece into the second pot potrest mould.

41. Use a wooden stick to scrape the clay even with the surface of the plaster mould.

42. Use a comb to score the backsides of the potrests.

technical guide



43. Using a small ball of clay to lift the potrests from the mould.



44. Apply slip to the scored surfaces.



45. Use two hands to press the potrests firmly in place. The short flat side should be horizontal on top.



46. Use the fingertips to smooth the edge of the potrest onto the rim. Use your other hand for support on the other side.

Adding the buttresses



47. Press clay into the buttress pressmould.



48. Scrape off excess clay using a 'wooden stick'.



49. Use a comb to score the backs of the buttresses



50. Use a small ball of clay to lift the buttresses from the mould.



51. Use a sponge or a brush to apply slip to the buttress backs and the second pot hole where they will join.



52. Press the buttresses in place. Smooth the joint with fingers.

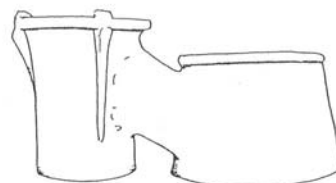

53. The completed buttresses.

Adding the flame shield



54. Score and slip the rim between the two potrests closest to the firebox.

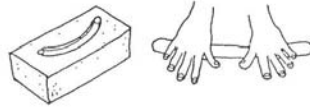

55. Roll out a coil of clay to fit in the flame shield mould.



56. Press the clay into the mould.

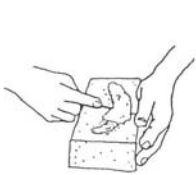

57. Scrape off excess clay so that the clay is level with the surface of the mould.



58. Using a fingertip, press a curved indentation that is level with the indentations in the plaster at the edges of the arc shape.

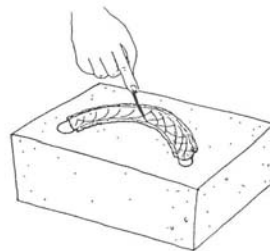

59. Use a sharp point to score the back of the shield.

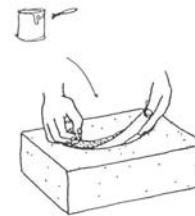

60. Use a small ball of clay to lift the shield from the mould. Apply slip to the scored areas.



61. Place the shield on the rim, and press to make a strong joint.

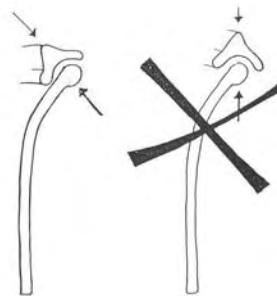

62. Note that the shield should be placed at the angle shown and not pointing vertically.



63. Use an aluminium pot to check that there is a very small gap above the shield. The pot should sit on the potrests, not on the shield.

Adding the door



64. Place the door template so



65. Use a sharp knife to cut



66. Use a comb to score

the door will be perpendicular to the length of the stove.

around the metal template.

around the edge of the door.



67. Roll out a coil about 2" thick from stiff clay.



68. Press flat.



69. Place onto the door mould.



70. Press clay to fill the mould.



71. Cut excess clay along the same angle as the mould so the door will fit the firebox.



72. Remove excess clay from the top and sides.



73. Score and slip the surface to be joined.



74. Place the door and mould against the firebox, aligning the mould with the door opening.

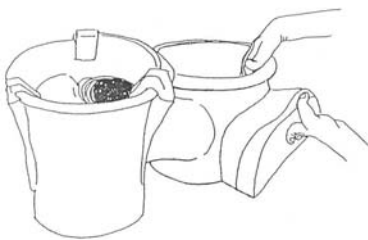

75. Using one hand inside the firebox, 2nd one hand on the flat side of the mould, push the door piece onto the firebox.



76. Use fingertips to press the joint together firmly.



77. Smooth the joint.

technical guide

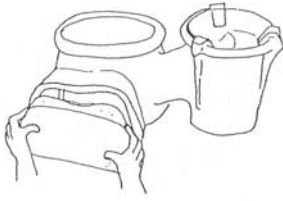

78. Remove the mould.

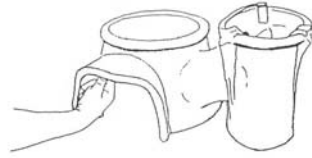

79. Press smooth the inside of the door joint.

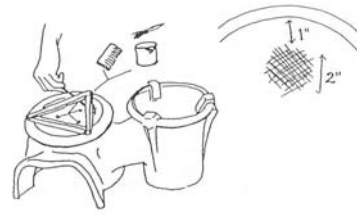

80. Place the triangle template so that one point is on the side of the firebox. Mark inside underneath the points. One inch below the rim, score and slip a 2" diameter area.

Adding the firebox potrests



81. Press clay into the firebox-potrest mould.



82. Scrape the mould with a wooden stick.



83. Lift the potrests with a ball of clay.



84. Score and slip the back of the potrest.

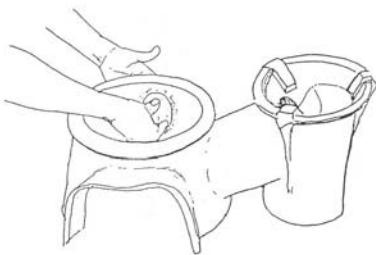

85. Press each potrest firmly onto the firebox wall. Support the wall with the other hand.



86. Press the edges of the potrests, making a firm joint. Use both hands.



87. Smooth the edges.

Cutting the holes

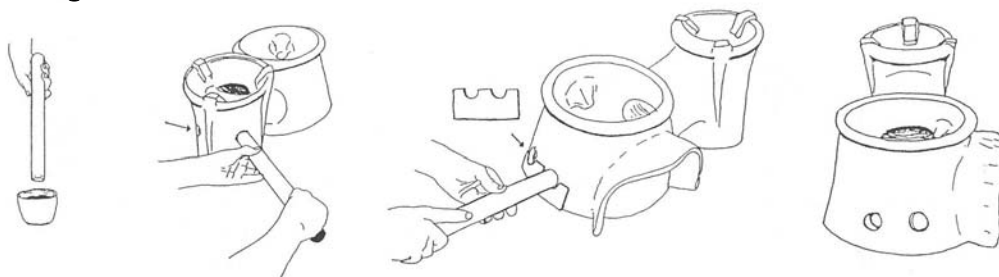

88. Dip the pipe into oil before each cut.

89. Cut two holes into the back of the second pothole piece.

90. Place the metal airhole template against the firebox side. Cut 2 holes directly opposite the tunnel.

91. The finished air holes

Final

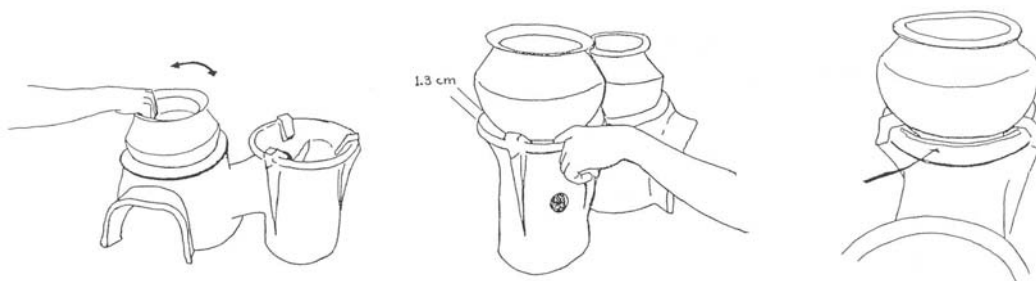

92. Piece the aluminium pot on the firebox rim. Rotate it to check that the rim is perfectly round, and that the potrests are not too high.

93. Use the pot over the second pothole to check that the potrests are 1.3 cm (just over 1/211) high. A finger should fit in the gap up to the middle knuckle.

94. Check that the flame shield does not take the weight of the pot.

Smoothing and marking the stove

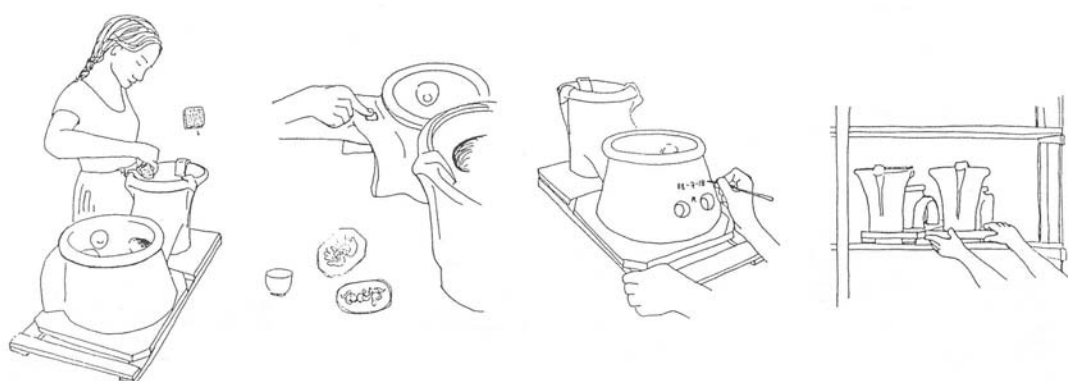

95. Rub the stove with a damp sponge.

96. Stamp the stove with the factory logo and the Anagi logo.

97. Write the year, month, and date, and your initial.

98. Place on shelves in a protected area for 3 days.

Finishing Procedure

After 3 days of stiffening indoors on the pallet, the stove can be removed from the pallet without distortion. At this time the final finishing is done to the stove. Sharp edges are carved away and those areas are dampened with a sponge. They are then rubbed with a wooden stick. The stick is then used to rub joints, especially the tunnel, baffle, and door joints. It is necessary to turn the stove upside down for most of this procedure. Either use a 3" thick stiff foam rubber pad, or support the shorter firebox with a cloth covered brick. The whole procedure should require only 10 minutes.

In some factories, the assemblers "finish" the stoves they assembled. In other factories, the finishing work is all done by one person.

Note: Configuration of brick with cloth covering as support for the stove while it is upside down. All other illustrations show the foam pad.



1. Here she is carving away any sharp edges around the door. She then rubs the areas with a stick.

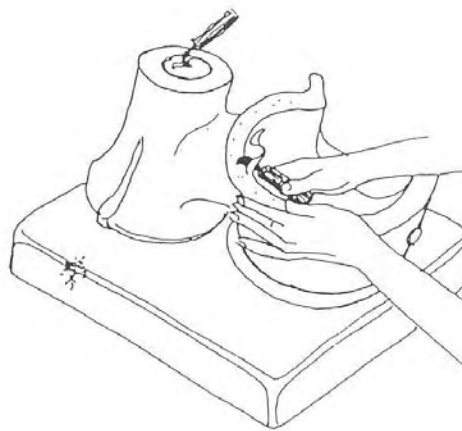

2. The sharp edges on the bottom of the fire box and the second pothole are carved away.



3. They are dampened with a sponge, and then rubbed with A wooden stick.

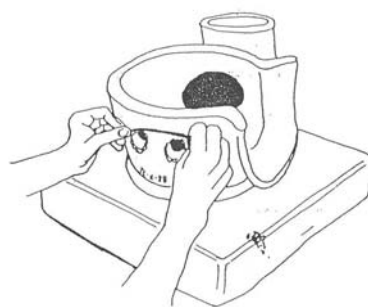

4. The sharp edges on the airholes are carved off with the knife.



5. They are then dampened and rubbed with a stick.

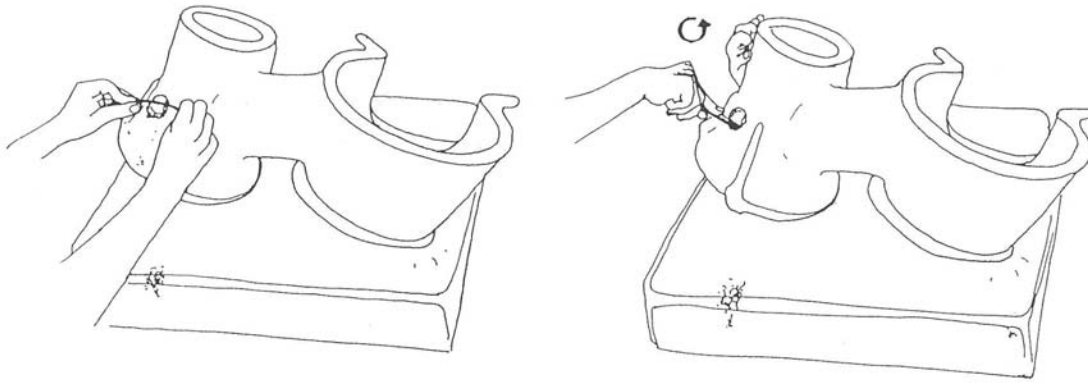

6 & 7. The treatment is given to the second – pot hole air holes

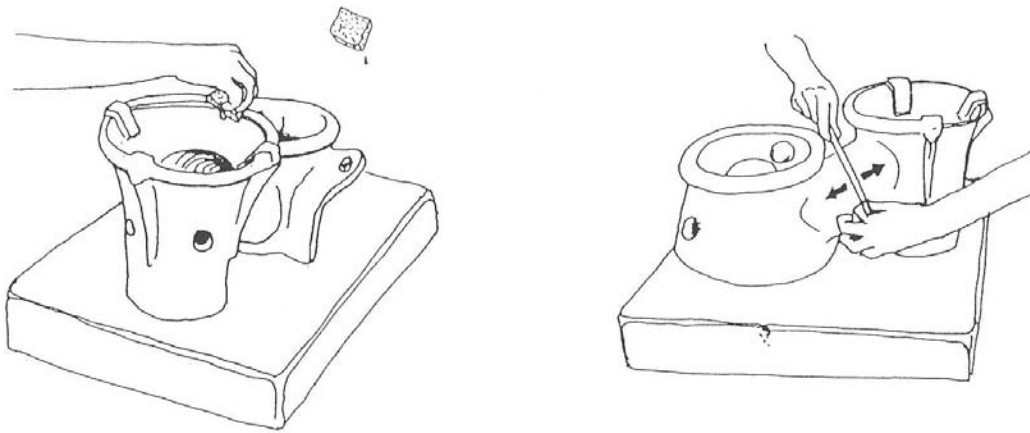

8. Any other rough areas are rubbed with a sponge

9. and then with the stick to give a hard, shiny surface.

Drying and Firing

After the final finishing, the stoves may be left to dry on racks or in a storage shed without the special pallet. The stoves should dry indoors, protected from sun, wind, excessive heat, and especially rain. Slow, even drying is necessary to prevent warpage.

The time required to dry stoves thoroughly is approximately 2 weeks. This will vary in the wet and dry seasons. In dry seasons, care must be taken to prevent the stoves from drying too fast. In wet seasons, care must be taken to see that the stoves dry thoroughly before firing.

The stoves should be checked for cracks before being placed in the kiln. This can be done by one of the assemblers. If a stove has cracks, it should not be fired but returned to the clay pile. Any cracks in the stove will get significantly bigger in firing.

Likely causes of cracking while drying include drying too quickly and unevenly and by joining pieces which are too dry with clay that is more wet.. Once such production problems are solved, it is rare for any cracks to occur during drying.

The stoves may be fired in traditional pottery kilns or in tile factory kilns. In the tile factories, stoves are fired on top of the layers of tiles, in space that is often unused. A maximum of 3 layers of stoves may be fired; more than 3 and the bottom layer of stoves will crack from the excess weight during the stress of firing. Up to 150 stoves can be safely fired in each kiln load. This is the output of one team (1 potter and 4 assemblers) in one week, and the firing cycle is one week. Therefore, a tile factory can fire the products of as many stove teams as it has kilns, without extra cost.

In traditional Sri Lankan potters kilns, the stoves should be fired for a longer time than is required for pots. The extra thickness of the stoves requires more time for the heat to penetrate.

In either kiln, the firing temperature range is 850 - 900°C. Darker-firing clay should be fired at the lower temperature; lighter-firing clays are better fired at or around 900°C. The top of the tile factory kilns is fairly hot, and the clay composition must be adjusted to the higher temperature. It has been found that mixing sand and extra grog into the tile clay has prevented overfiring problems. The clay mix currently in use is 8 parts tile clay: 1 part sand: 1 part grog (by volume).

Quality Control after Firing

After firing, the stoves must be checked for cracks or unacceptable warping. The thick rims of the design should prevent warping of the process, keeping them a desirable round circle rather than an egg-shape.

Stoves are placed in 3 categories: Grade A, which sells for full price; Grade B, which sells for half price, and Rejects, which are not sold at all.

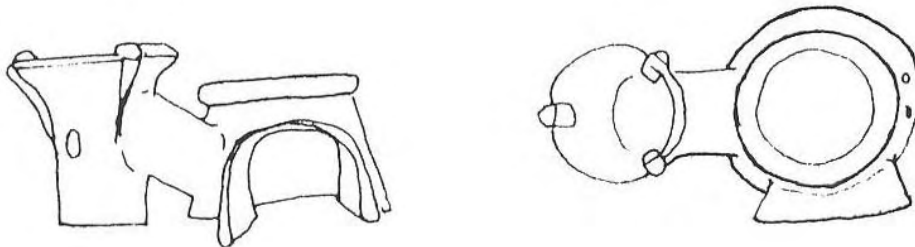

Grade A: no cracks

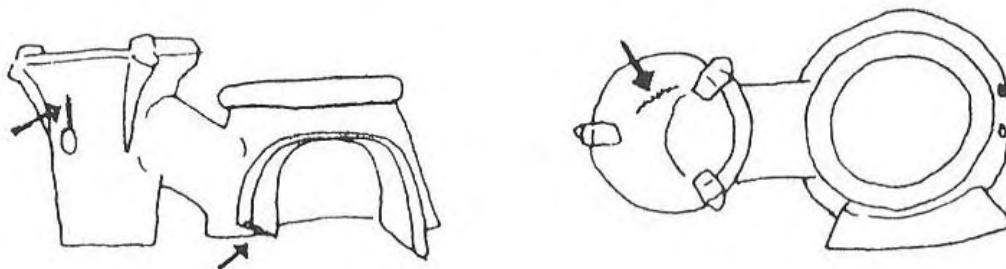

Grade B: cracks in the baffle, cracks or chips in the door piece, or a crack anywhere on the second pothole piece.

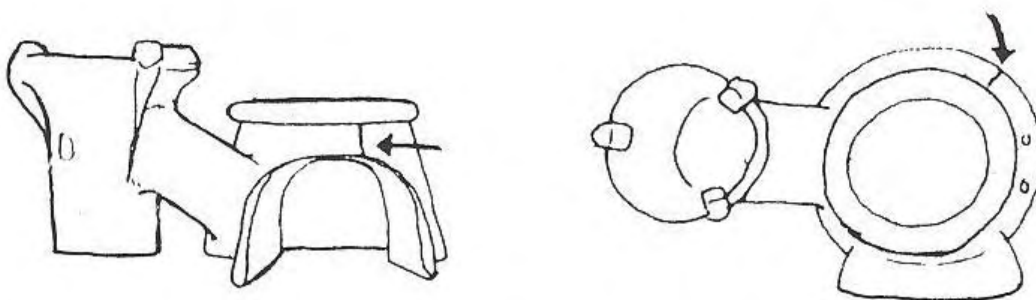

Rejects: any crack, no matter how small, in the firebox.

Coming from the kiln, stoves are checked visually for cracks, especially on the underside of the firebox. The stoves are also tapped for the sound they produce. The sound will be a ring like a quiet bell if there are no cracks, and a "thunk" if there is a crack. This is the same technique used to inspect pottery, and it will be "used on the stoves by customers in the shops.

Acknowledgements

Sri Lanka's Anagi II ("Excellent") stove is the result of a long standing collaboration between a number of organisations wishing to contribute to solutions to the problems of deforestation, smoky kitchens, and poverty.

Design, testing, promotion, and funding of the Anagi II stove has been done by the Sarvodaya Shramadana Movement, Ceylon Electricity Board, the Ceylon Institute for Scientific and Industrial Research, Practical Action (formally The Intermediate Technology Development Group), and the Overseas Development Administration (UK).

For further information:

Practical Action South Asia
5 Lionel Edirisinghe Mawatha
Kirulapone Colombo 5 Sri Lanka
Tel: +94 1 829412
Fax: +94 1 856188
E-mail: janathakshan@practicalaction.org.uk
Website: <http://janathakshan.com>

Practical Action
Schumacher Centre for Technology and Development
Bourton on Dunsmore
Rugby
CV23 9QZ
United Kingdom
Tel: + 44 (0)1926 634400
Fax: + 44 (0)1926 634401
E-mail: infoserv@practicalaction.org.uk
Website: www.practicalaction.org

Practical Action is a development charity with a difference. We know the simplest ideas can have the most profound, life-changing effect on poor people across the world. For over 40 years, we have been working closely with some of the world's poorest people - using simple technology to fight poverty and transform their lives for the better. We currently work in 15 countries in Africa, South Asia and Latin America.

Appendix 1 Pallet Dimensions and Plan

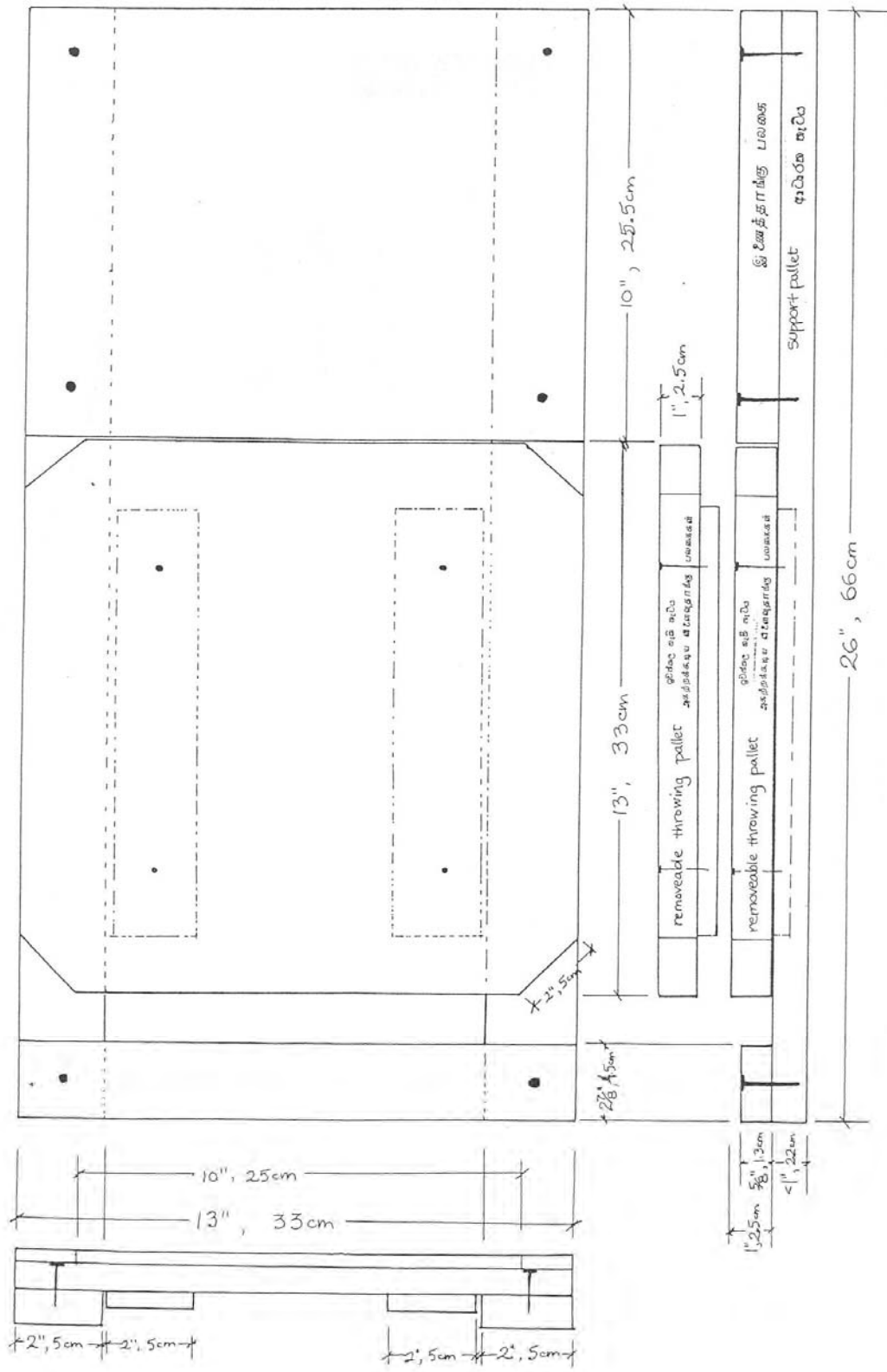

technical guide

Appendix 2: Full Size Patterns for Templates

Baffle (vinyl)

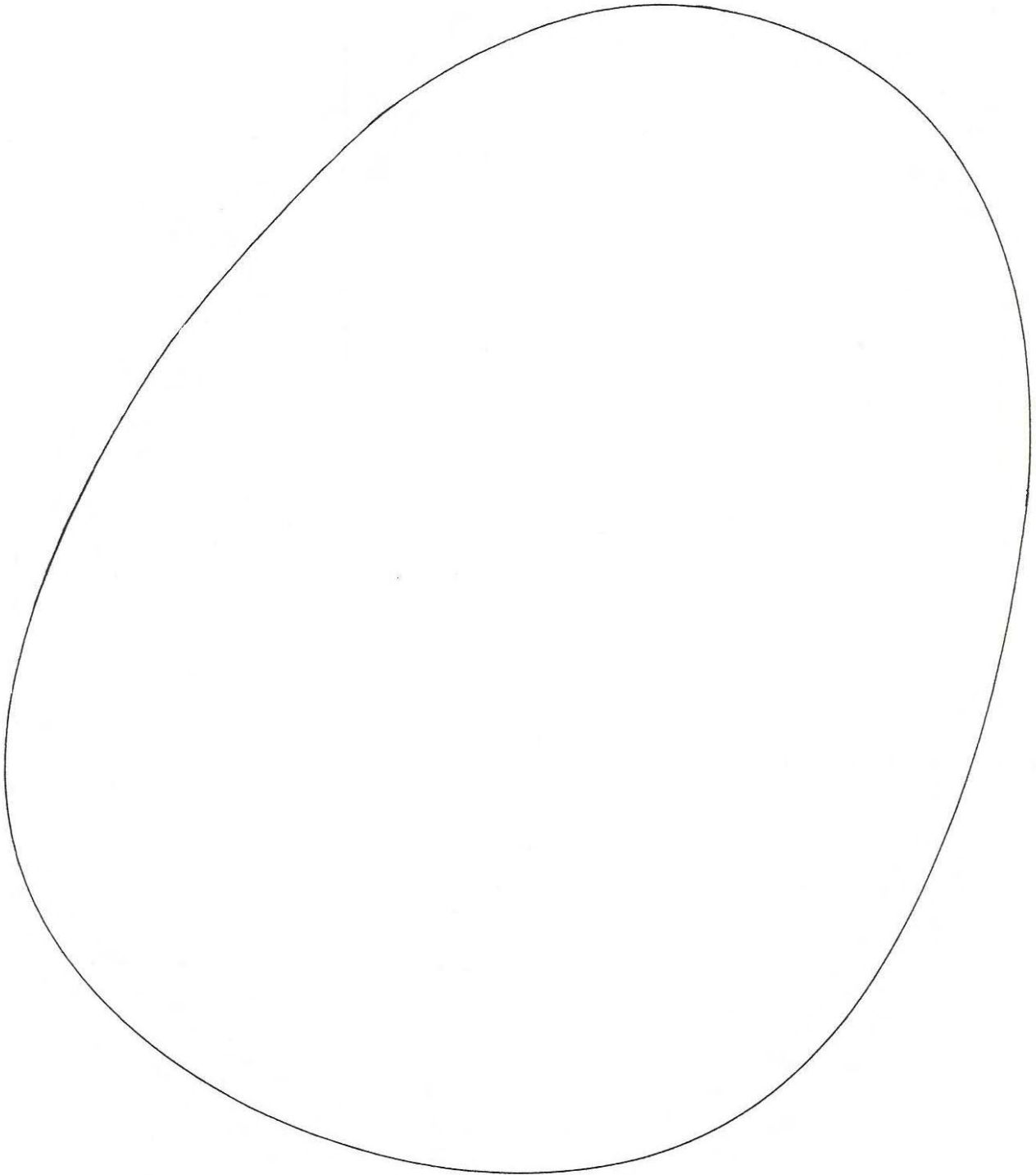

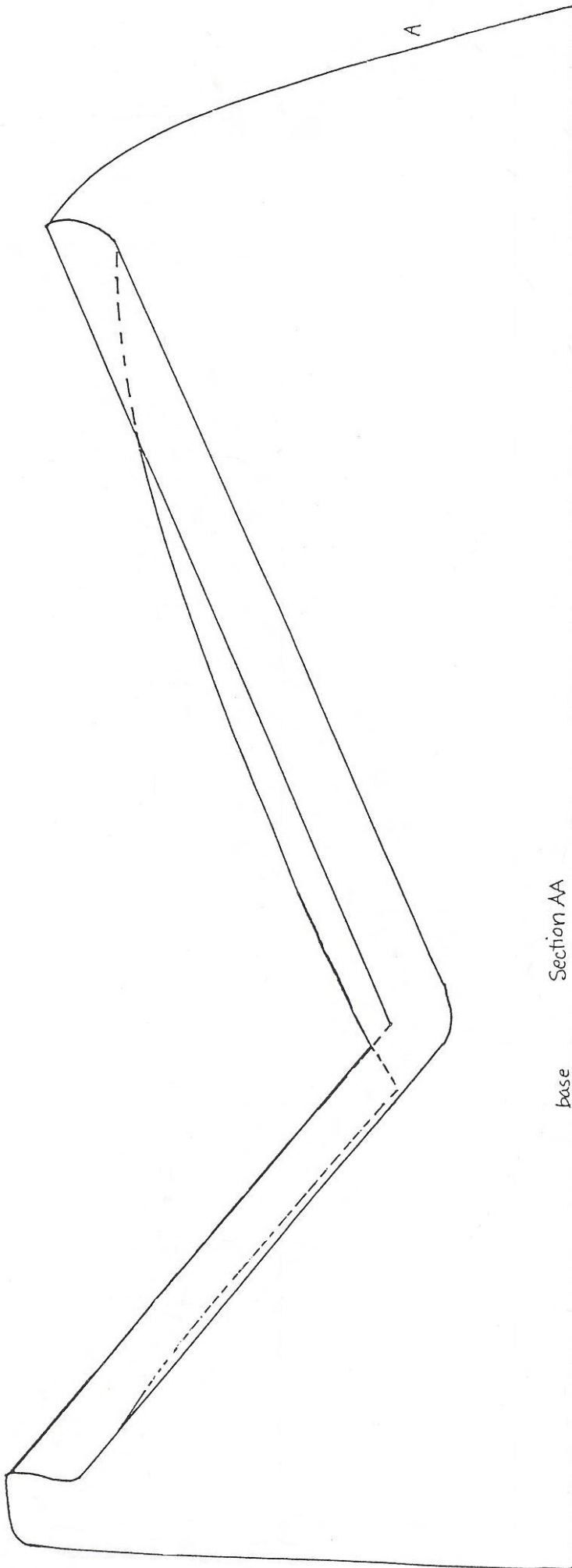

Baffle Mould Side View
Scale 1:1

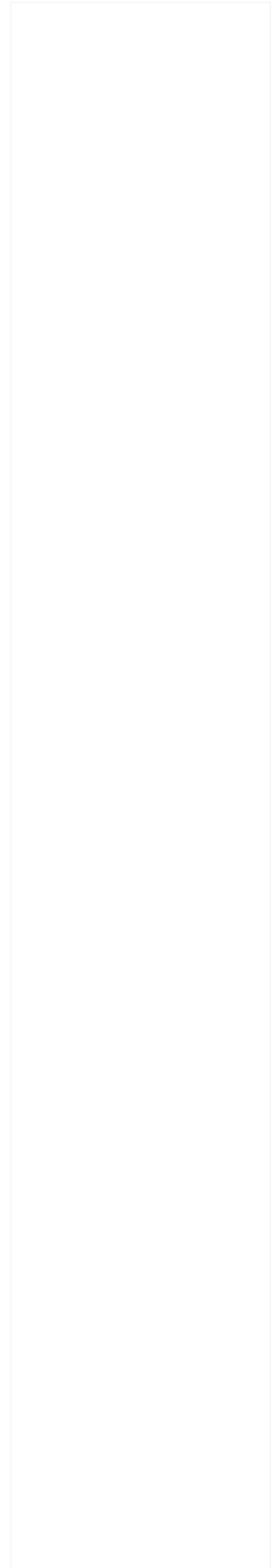

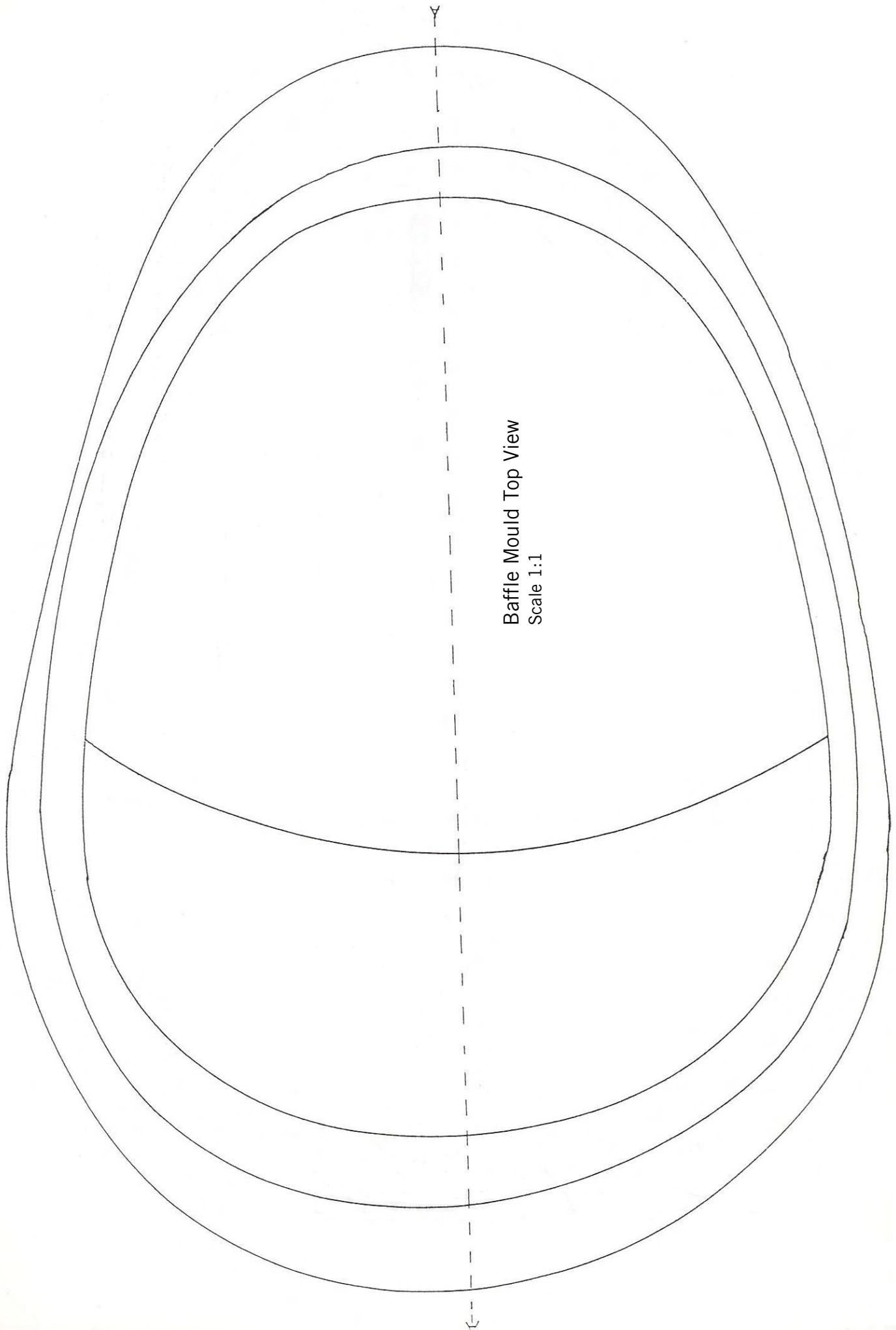

Baffle Mould Top View
Scale 1:1

Second pothole potrest mould
Scale 1:1

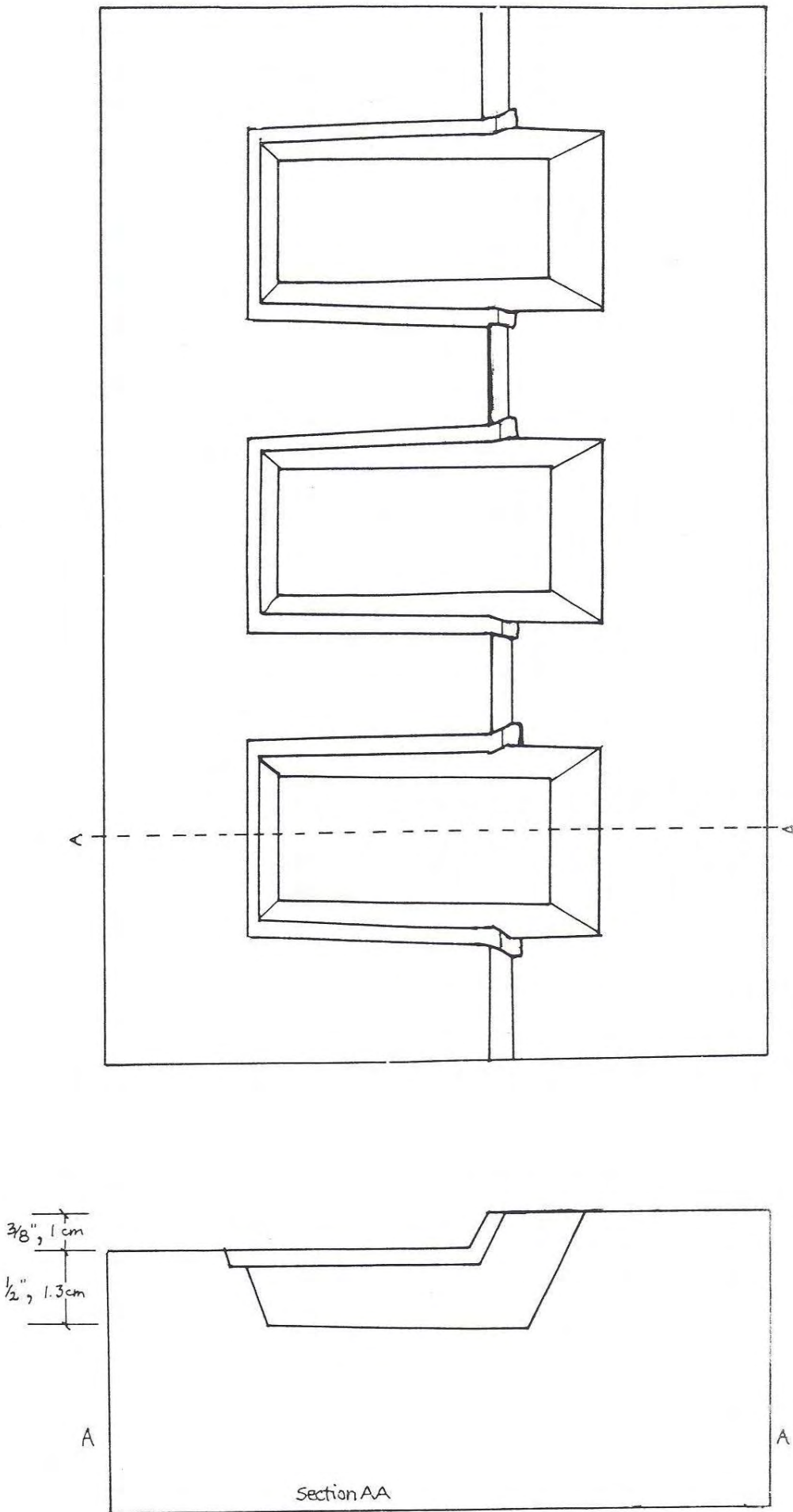

technical guide

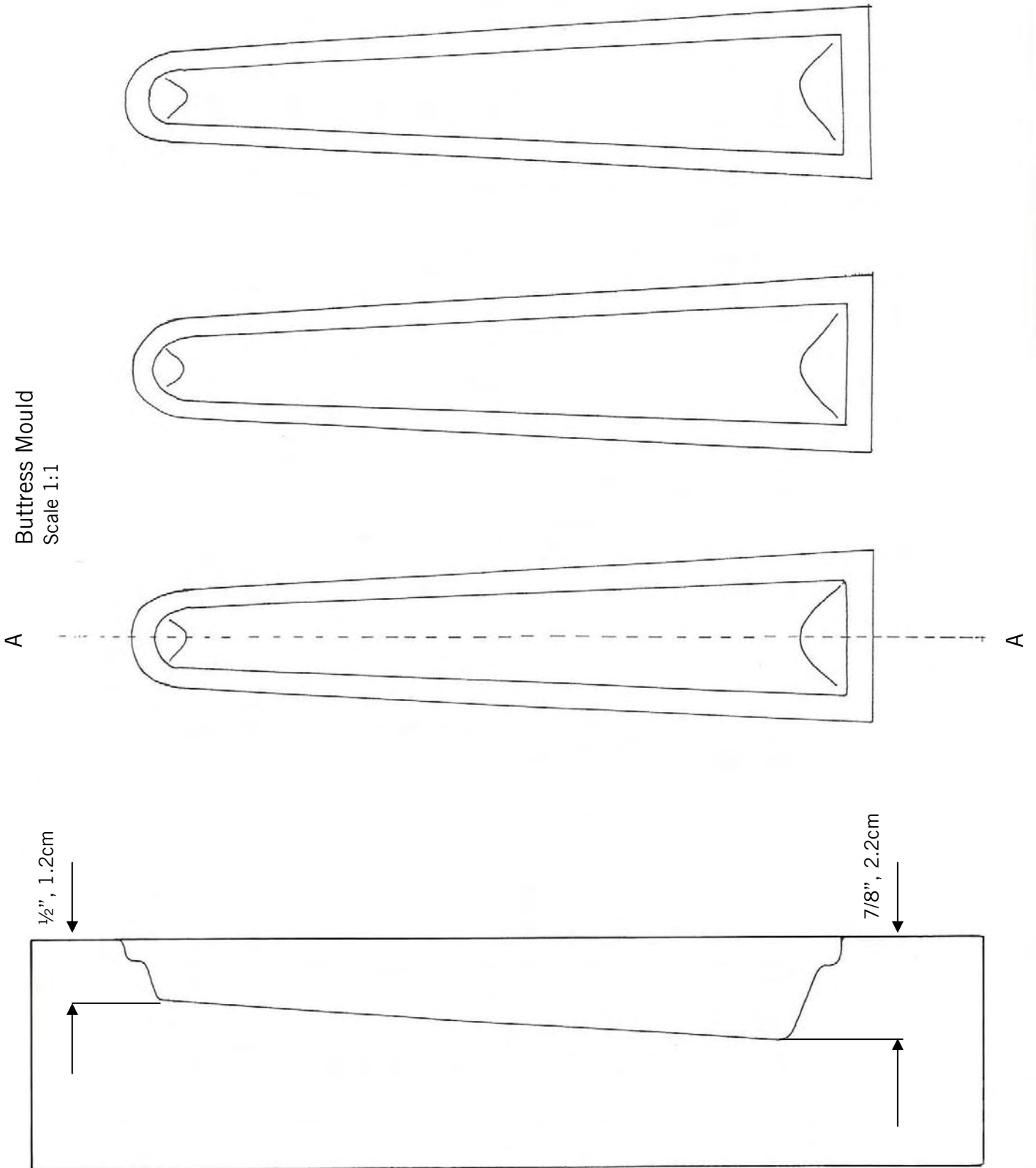

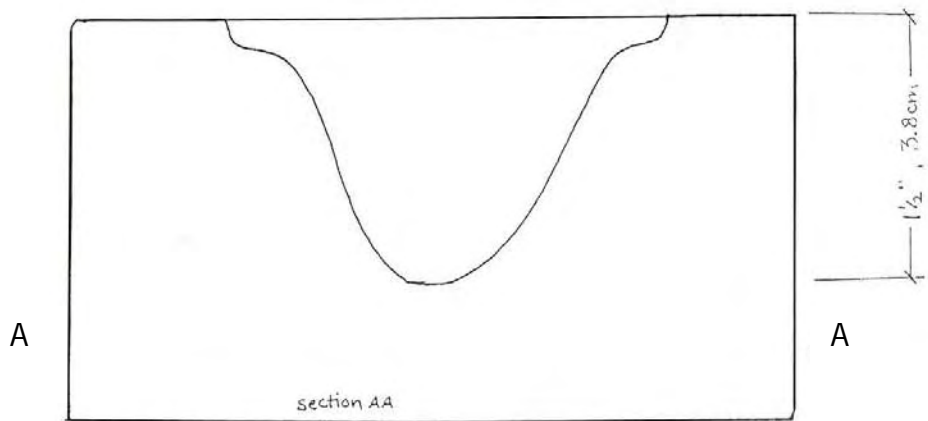
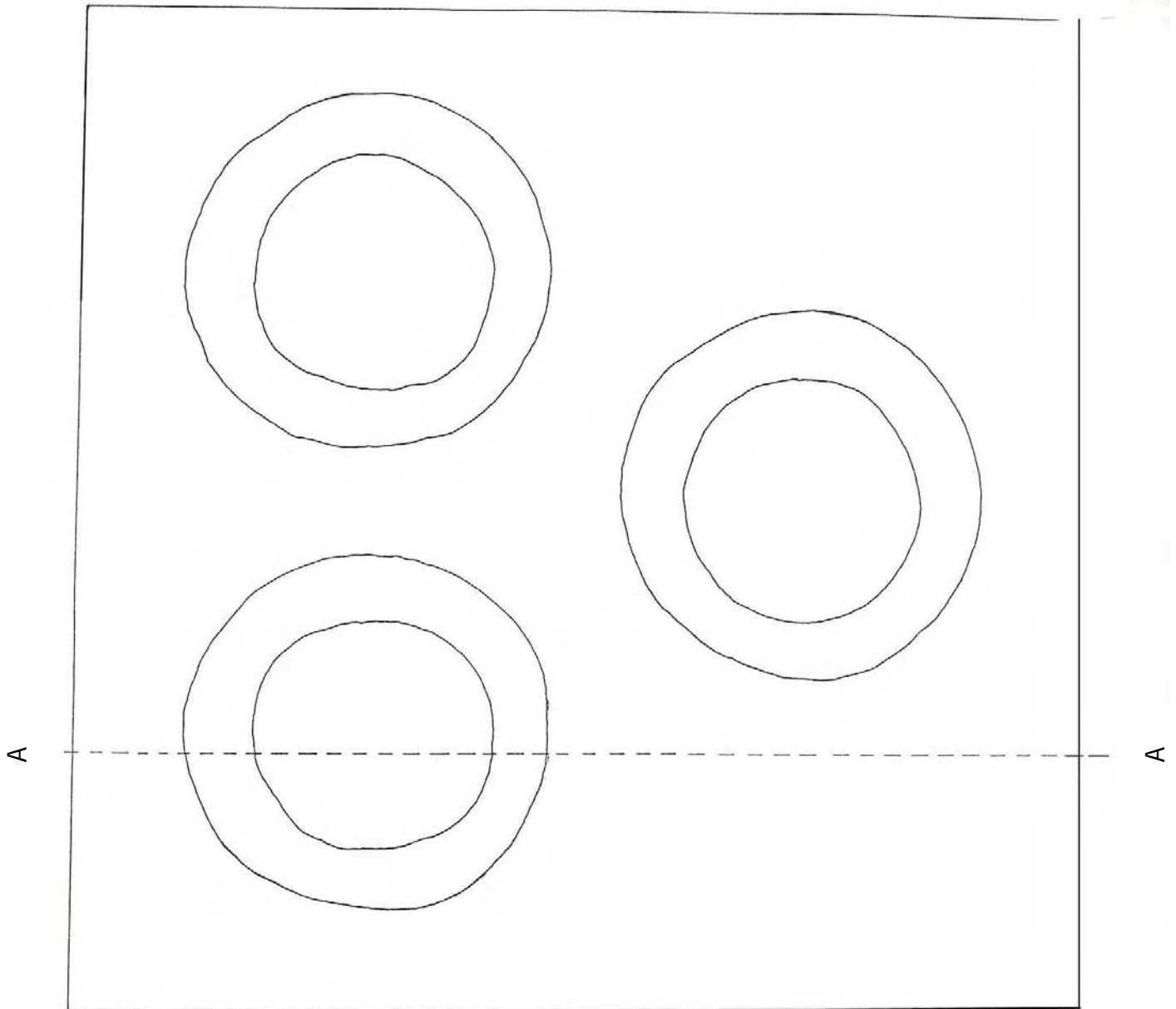

Firebox Potrest Mould
Scale 1:1

Second Pothole Inside Shape Template
Scale 1:1

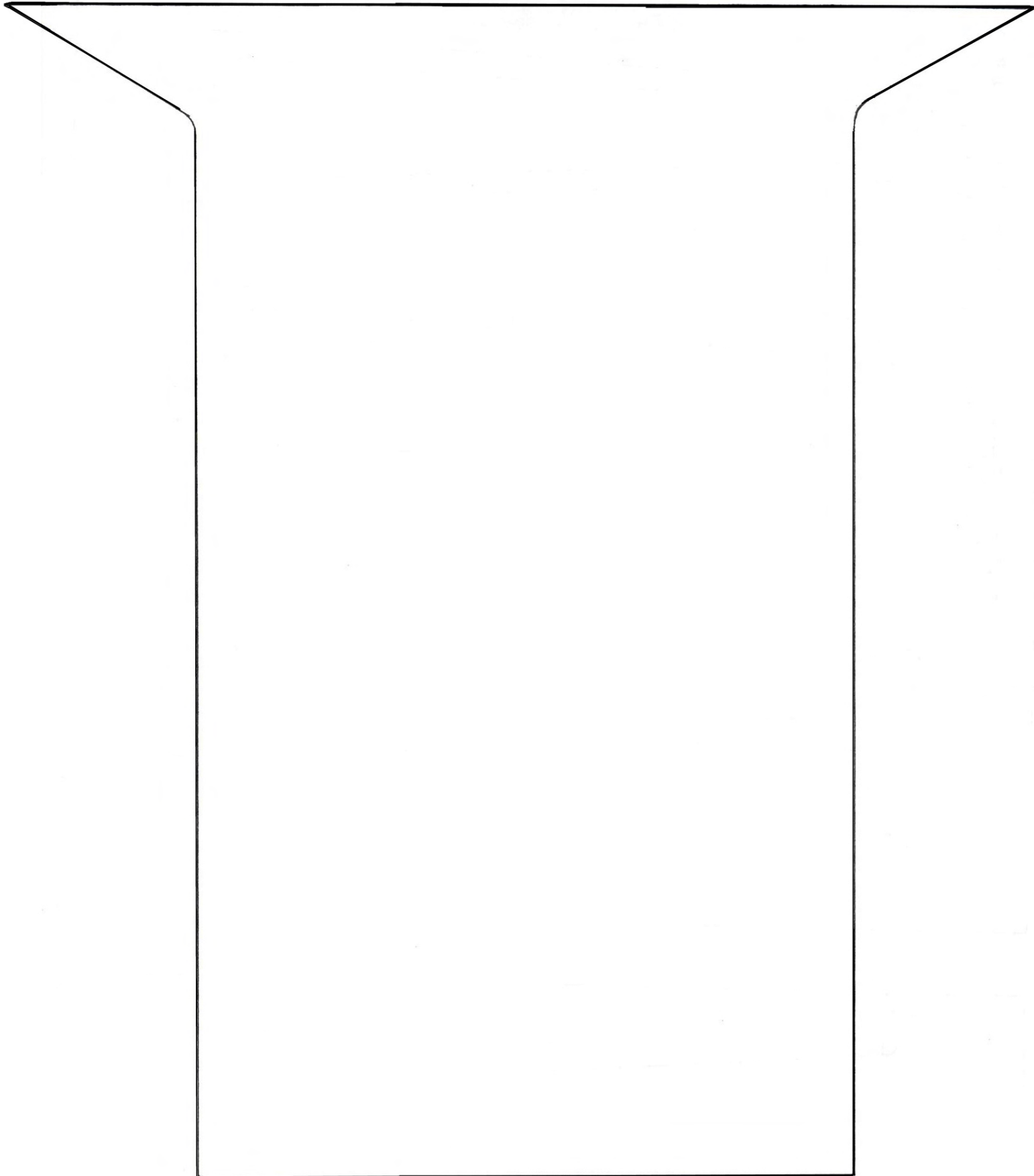

Potrest marker (wood)
Two alternative designs
Scale 1:1

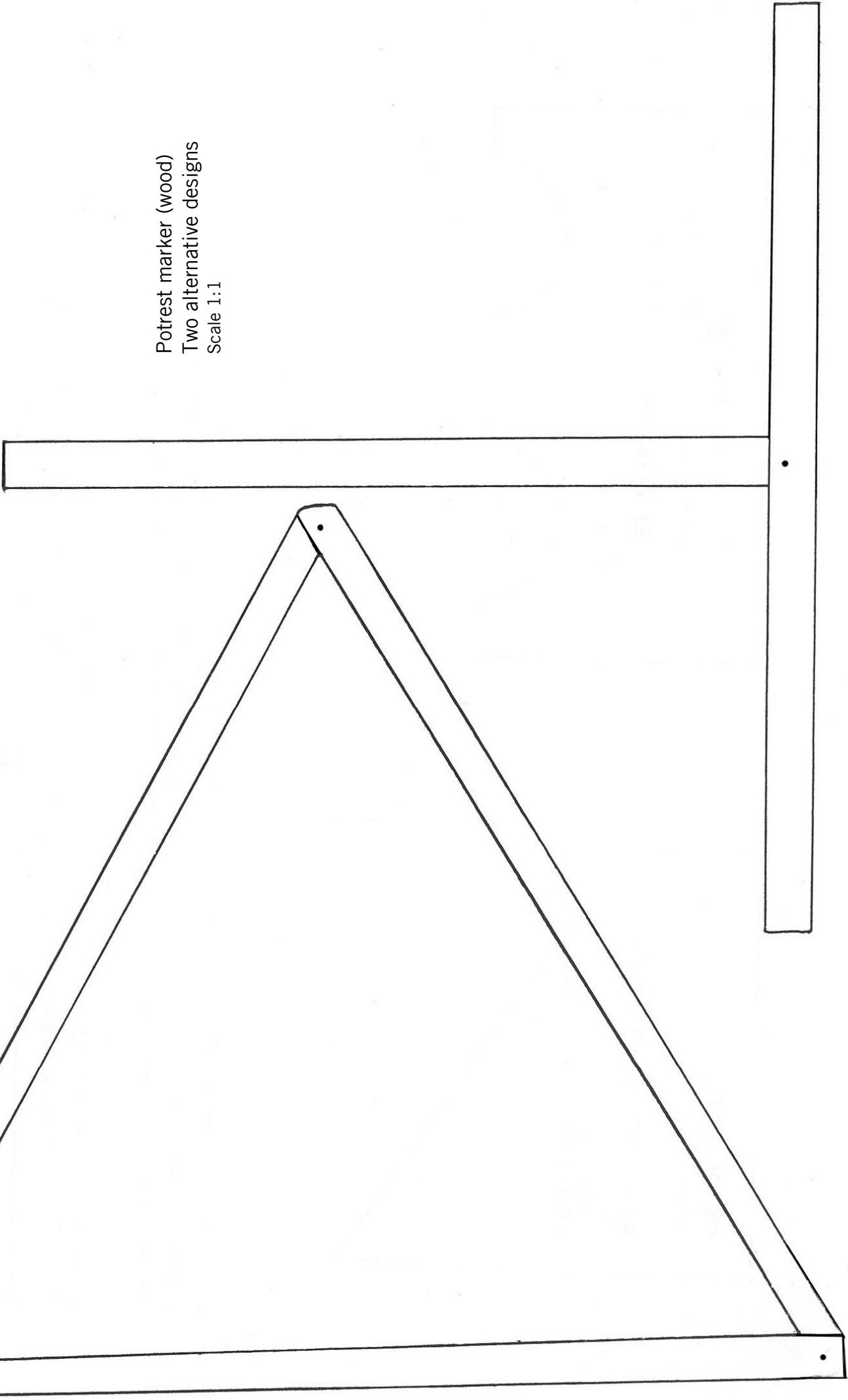

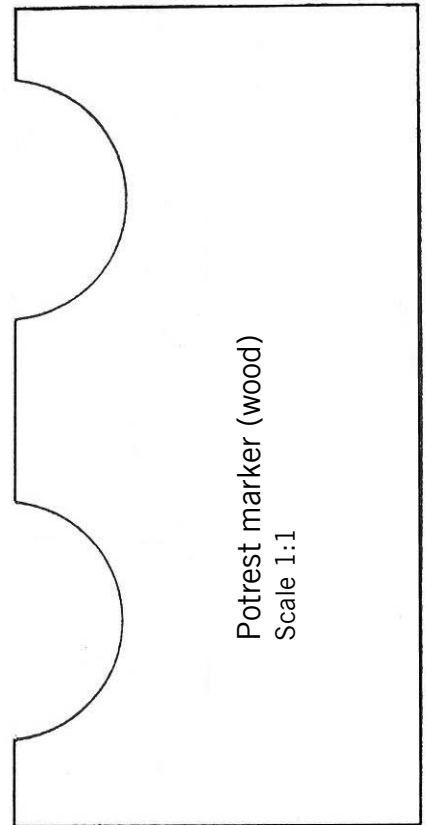
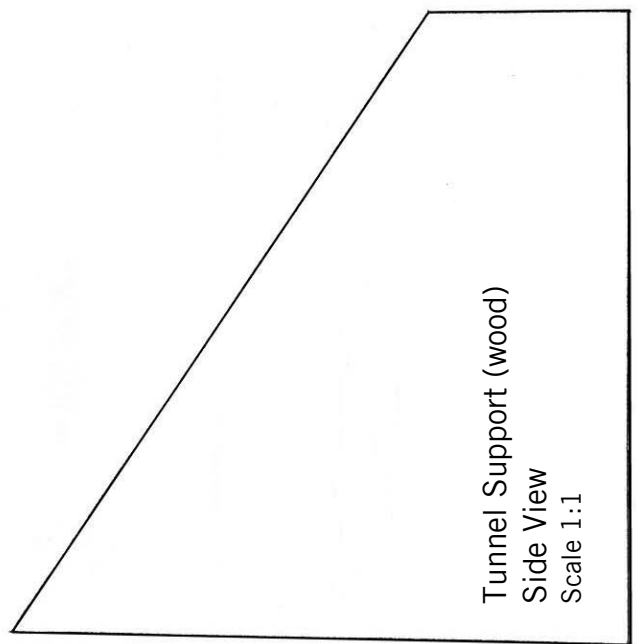
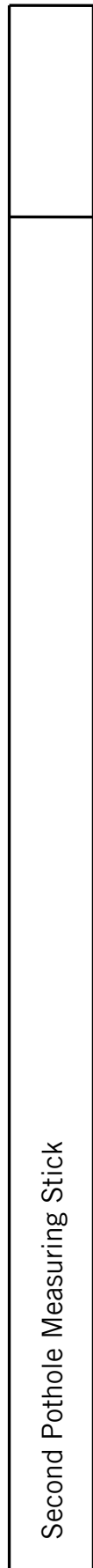
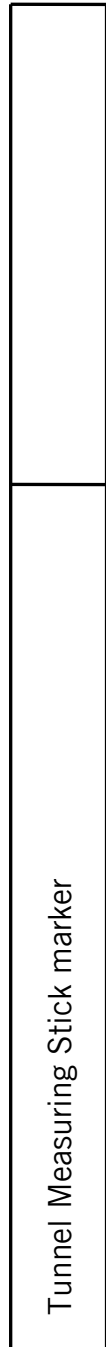

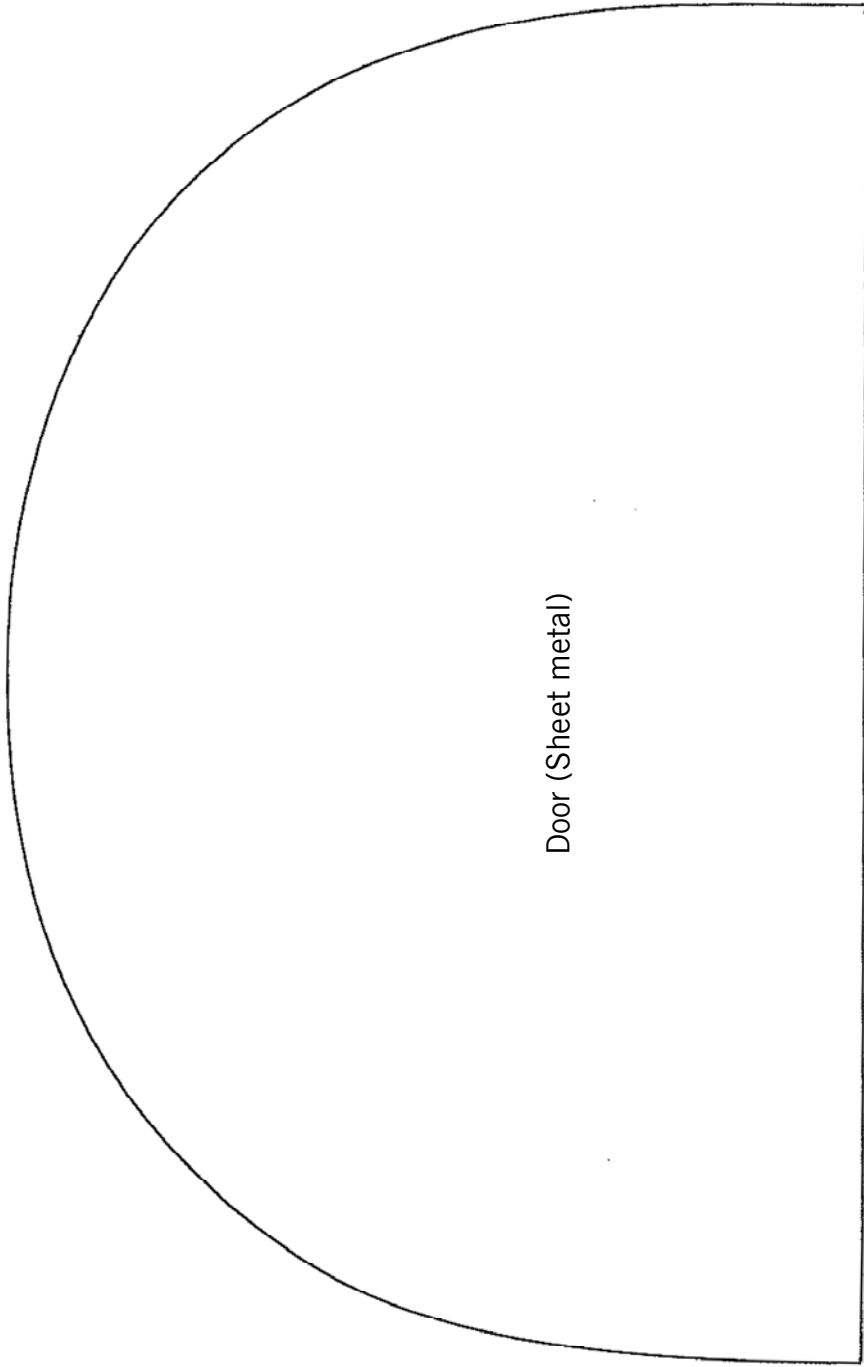

Door (Sheet metal)

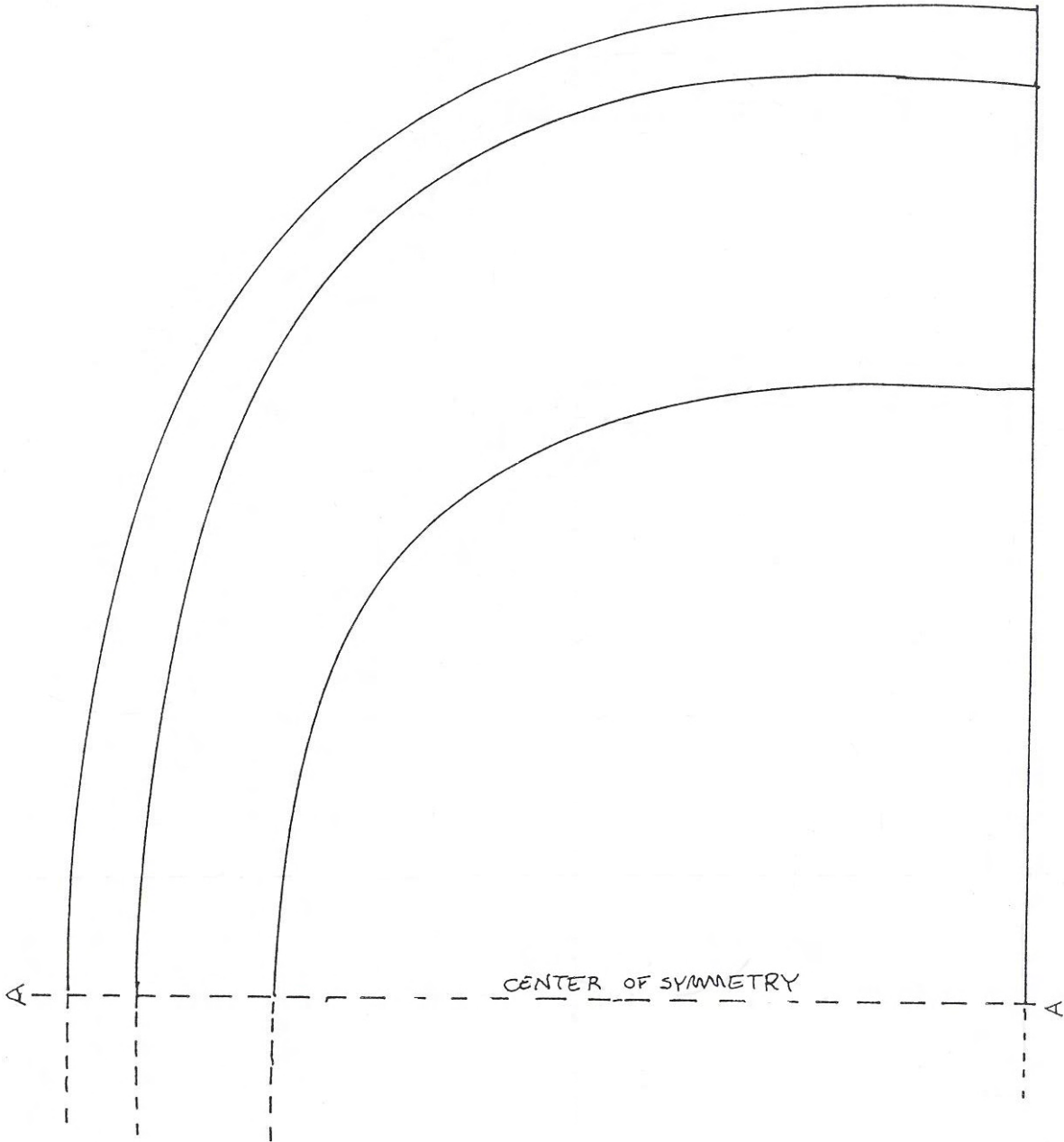

Door Piece Mould Front View
Scale 1:1

Door Piece Mould
Scale 1:1

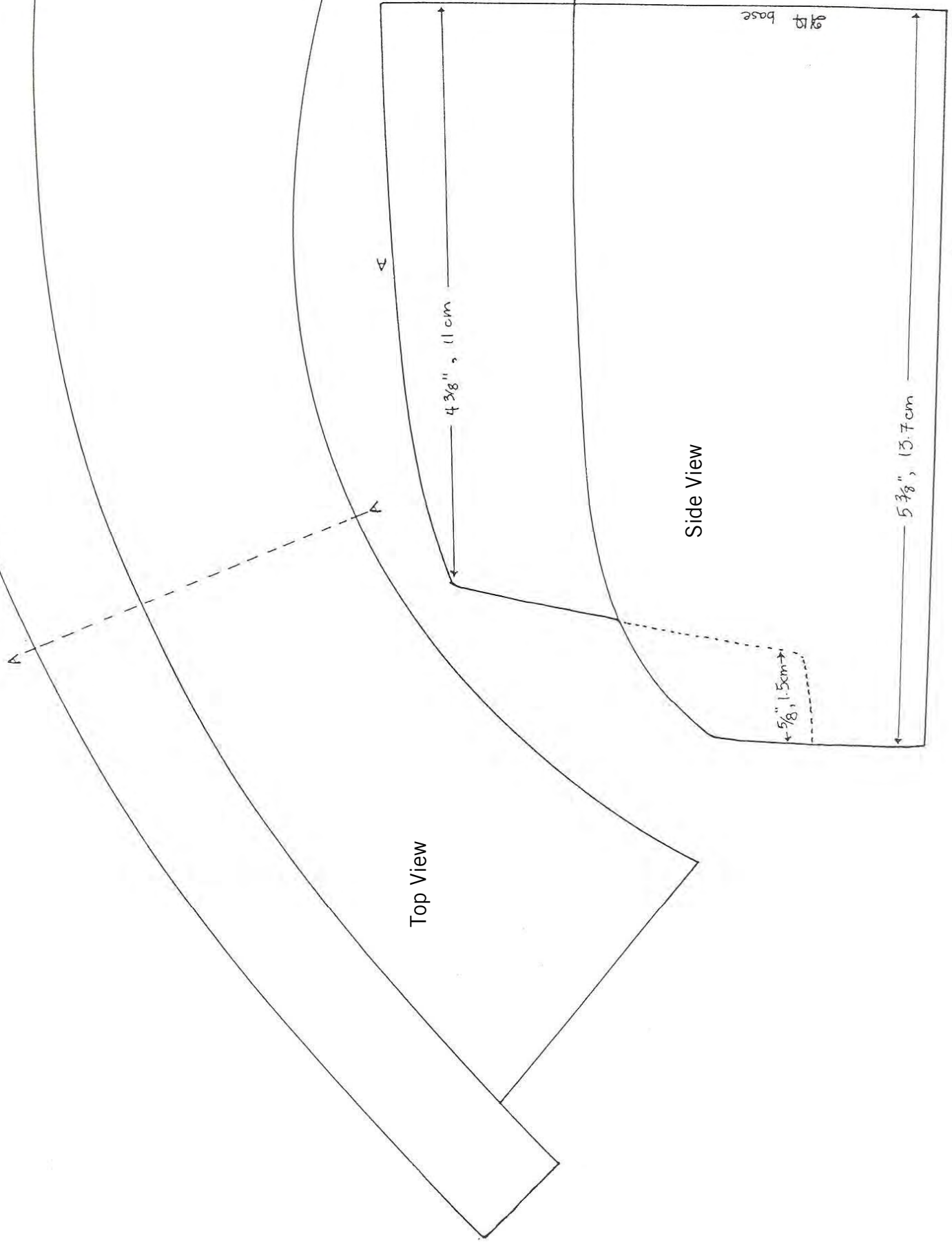

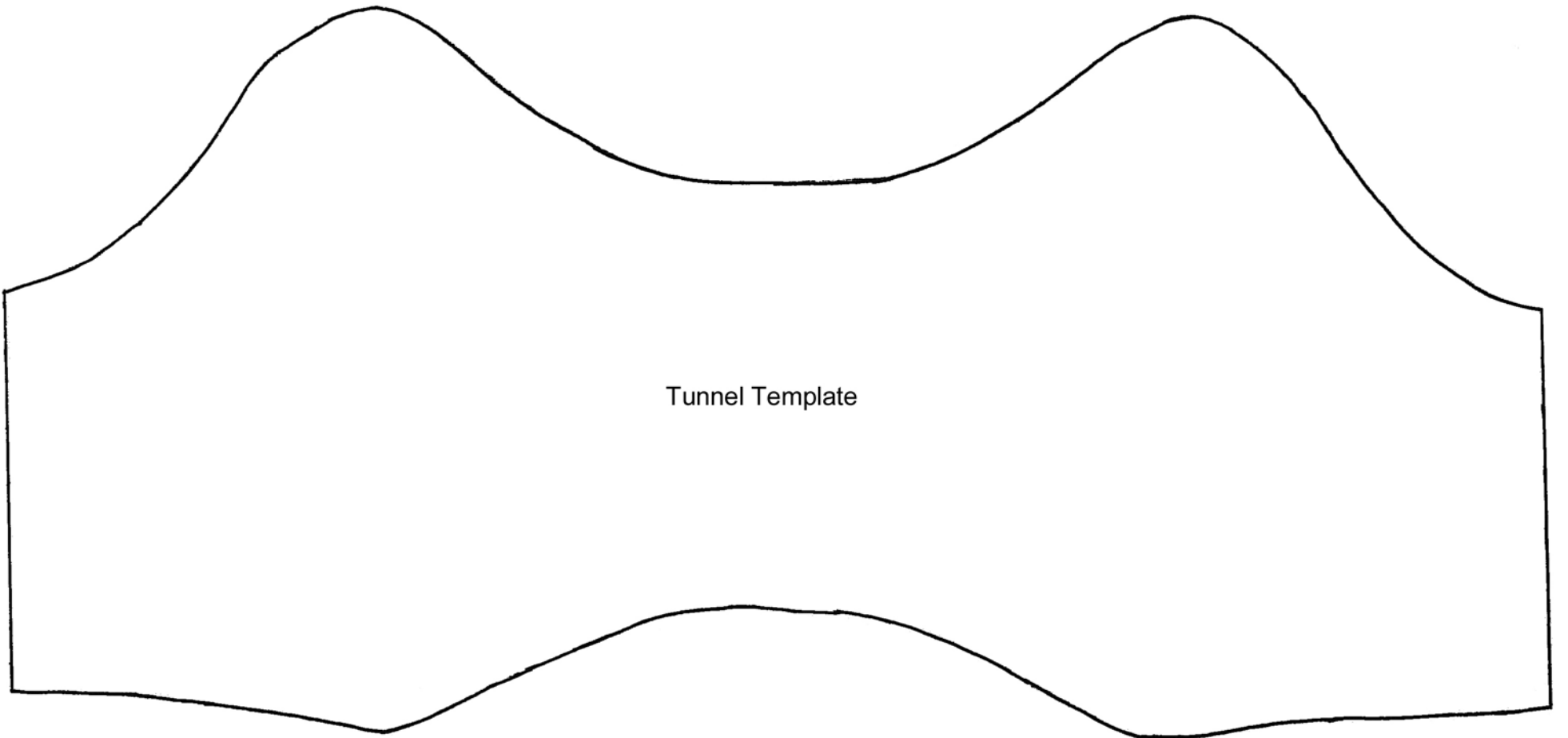

Tunnel Template

Flame Shield Mould
Scale 1:1

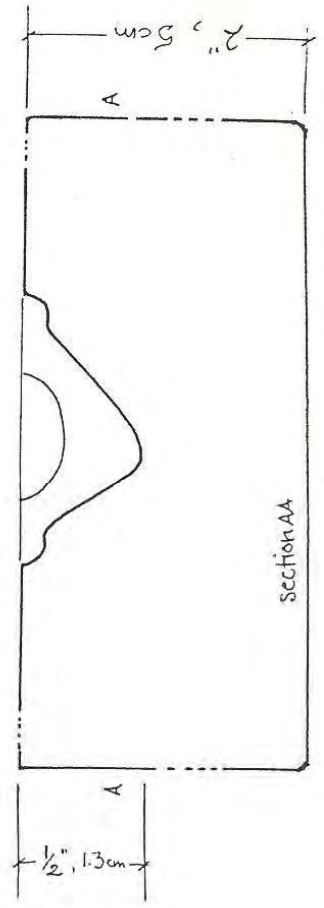
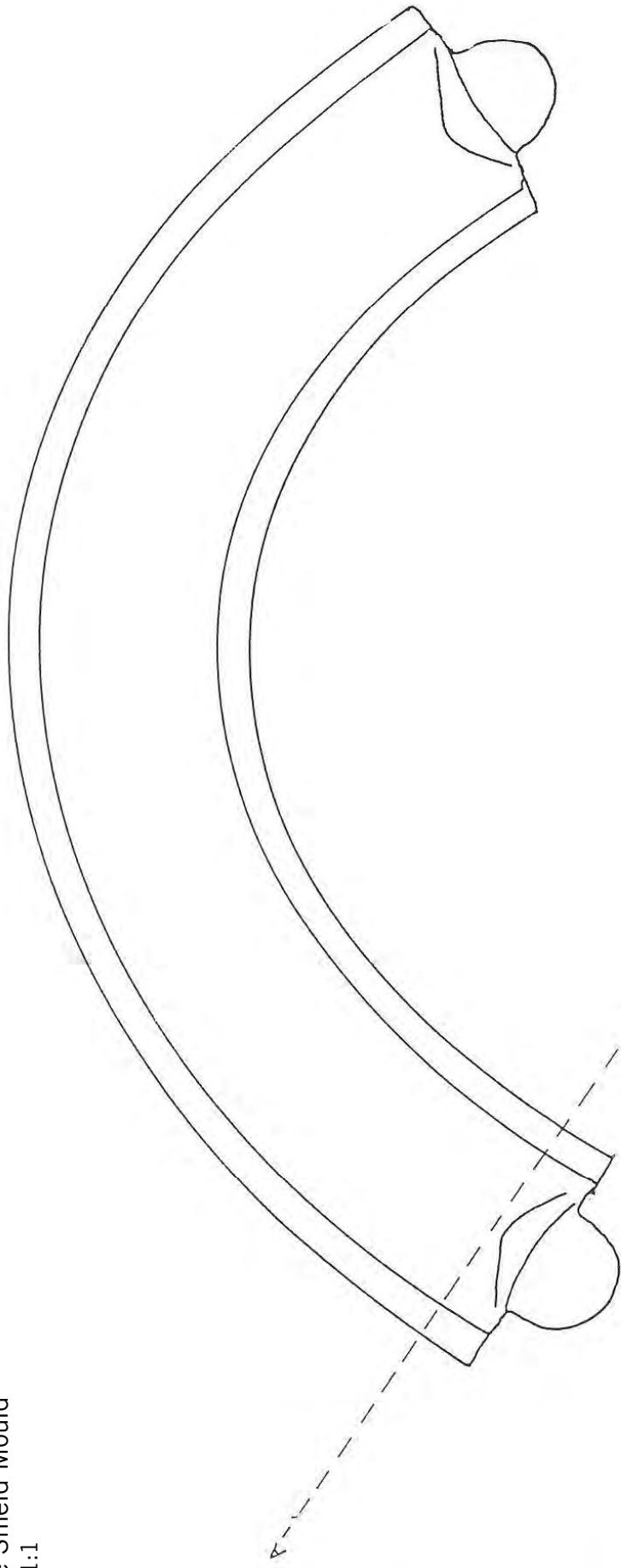

Appendix 3. Making the moulds

Making plaster moulds is best learned from an experienced mould maker. The following instructions can serve as a guide.

The moulds for the smaller attached pieces on the Anagi stove are made of plaster of paris. The moulds are cast from a master mould, which can be made from wood or plaster. A temporary master mould can be made from clay by forming pieces just like you wish to make using the moulds, and laying them on a sheet of glass or a slab of clay.

1 The master moulds are set on a table with slabs of clay used to form walls where necessary.

2 The master moulds are coated with oil, or with liquid soap, or with clay slip, to keep the poured plaster from sticking to them. Only when the moulds are ready can the plaster be mixed.

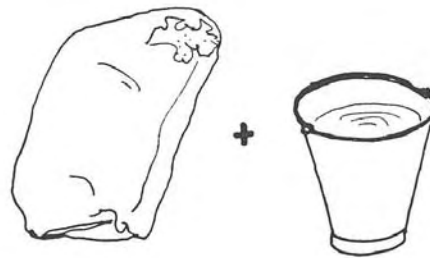

3 Fresh, dry plaster of Paris is mixed with clean water. The proportions are roughly equal, but the only practical accurate measurement is by acquiring a feel for the consistency. If too much water is used, the plaster will be soft and weak. If too much dry plaster is used, the plaster will not pour smoothly and will have a rough and uneven texture.



4 Add water to the plaster (or plaster to the water if you prefer), mixing continuously with one hand. Add ingredients until the mix has the consistency of heavy cream. It is important to add the ingredients fairly quickly, in less than one minute, but also carefully so as not to add too much of one thing. If you are unsure of your skill, make smaller batches of plaster (enough for one mould).

5 Continue stirring the plaster and water with your hand. It should thicken within a minute or two. When the plaster starts to feel warm (due to a chemical reaction), and it coats the hand like an opaque glove, then it is ready to pour immediately.



6 Pour the plaster into the prepared moulds quickly, scooping out the thickening plaster as needed. Pour to the top of the moulds, avoiding making air bubbles. Tap on the sides of the moulds to encourage air bubbles to rise while the plaster is still liquid. Wash hands immediately after pouring is finished!

7 Wait at least 1/2 hour until the plaster has hardened, to remove the clay walls. Tap on the joints to remove wooden or plaster master moulds. Clay master moulds are usually destroyed while relieving them.

8 While the plaster is still damp, it is soft enough to easily carve. Use a



strong steel blade to carve the sides and bottom flat. Bevel the corners to prevent them from chipping.

- 9 This illustration shows the 6 master moulds for the Anagi II stove, with their resulting plaster moulds. The moulds should be allowed to dry thoroughly before using them. If used while wet and weak, they will be ruined by the scraping in only a few days. Dry plaster moulds can last for about 6 months then they should be replaced with new ones